

Versatile

Precision Punches, Guides & Die Buttons

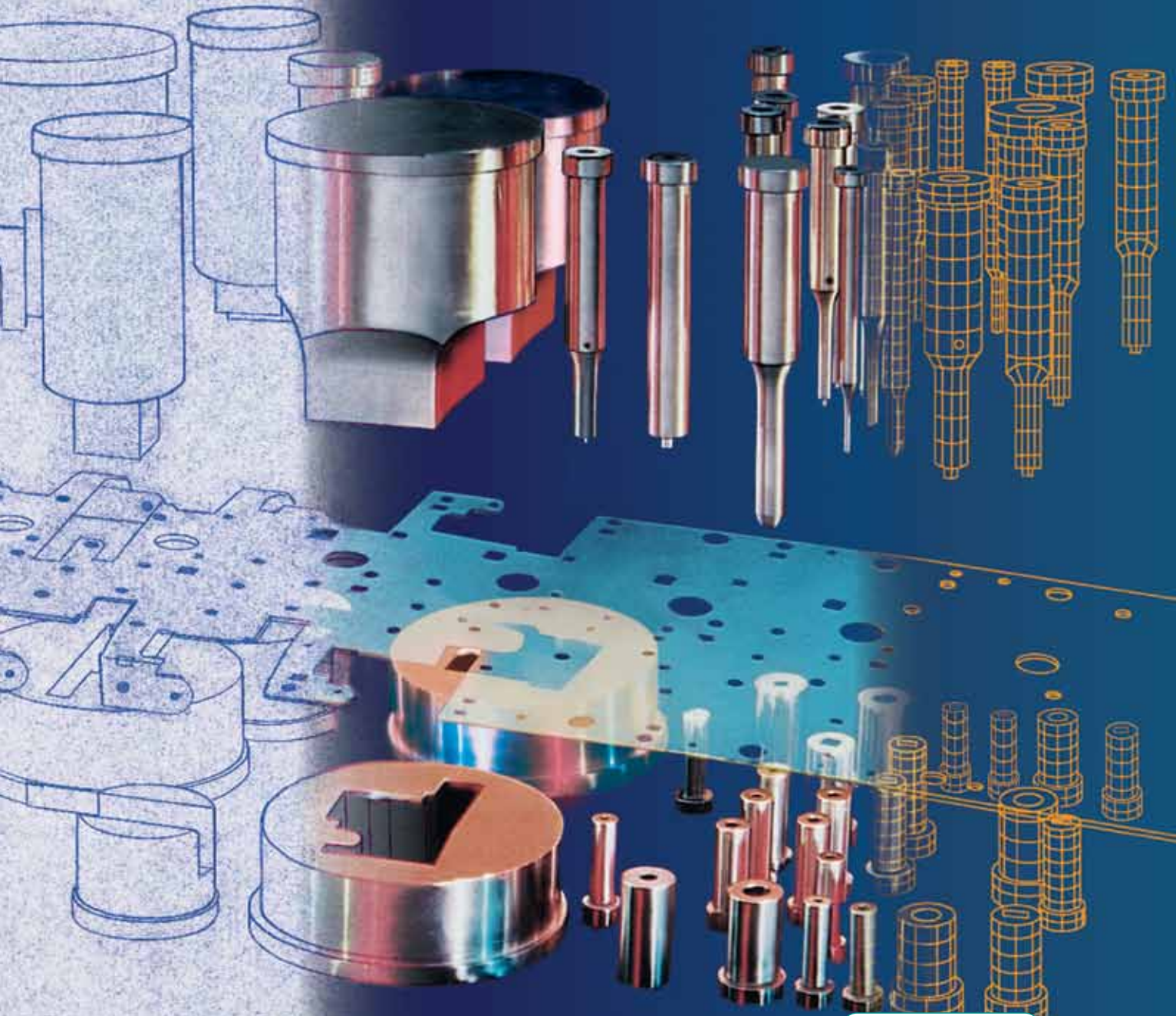

a MISUMI Group Company

Versatile Products

The Leading Edge
of Technology

Versatile Saves Design Time

This catalog is designer-oriented and easy to use. Component callout is fast and accurate. Versatile products save tooling area — more shape can be designed into each Versatile die button with its taper relief than can be designed into a conventional counterbored relief. This feature alone can save one or two stations per die.

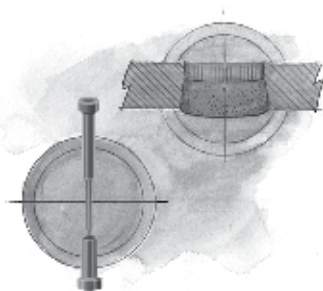

Versatile Alignment

The most critical and most difficult of all requirements in die building is alignment — getting the punch in line with the die button with equal clearance. Alignment has the greatest effect on die productivity. Without it, misalignment increases wear and creates bending stress on the punches that greatly increases the risk of breakage.

Versatile's precision tolerance and concentricity gives three times better alignment. Dies run better with Versatile. Better alignment — longer runs, less downtime and better parts.

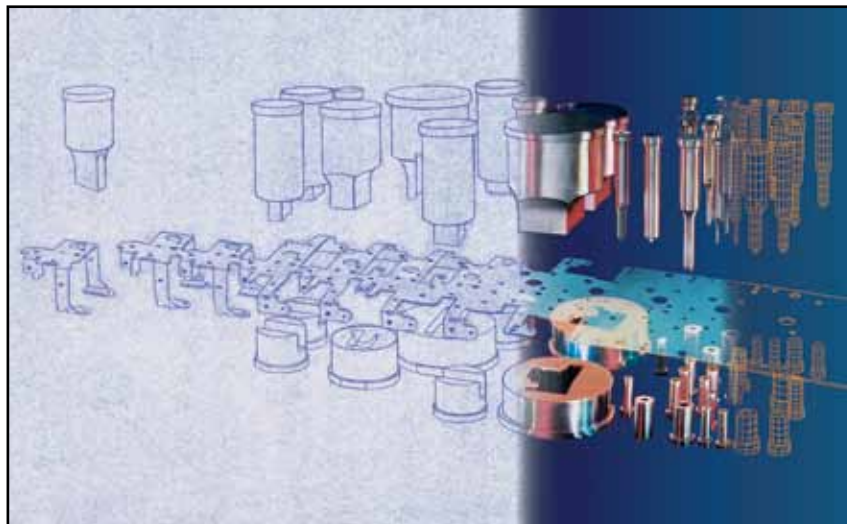

About The Cover

Time has a way of testing and proving the worth of anything that man has developed. Progressive dies, as a means of producing large quantities of precision stampings, have withstood the test.

Progressive dies haven't changed drastically over the years, but the methods of producing them have. From layout dye on steel, to numerically controlled machines, to computer aided manufacturing; present day equipment has taken some of the art out of die building and has automated some common tasks and created some efficiencies in building and maintenance.

Die design is following that same pattern. Beginning with product drawings, die designers produce a design from which blueprints are made. Blueprints are rigid and changes are time consuming and expensive to make. Now we have Computer Aided Design. With the arrival of CAD there are options. We can see both the die progression and the components and change them easily if necessary. More and more dies become reality from CAD, however, today the finished die can be a result of both processes as the photograph depicts.

Jektole® Punches and Clearances

Jektole, DAYTON's slug ejection punch, permits doubling punch to die button clearance, produces up to three times the number of hits between sharpenings and reduces burr heights.



Dayton Slug Control Guaranteed to Stop Slug Pulling

Dayton Slug Control is a guaranteed method of reducing the risk of slugs being pulled to the die surface during

withdrawal of the punch. The slugs are trapped in the land of the die button until they fall freely through the relief. It has no effect on hole size and will not require any changes in your regrind practices. Dayton Slug Control is effective throughout the life of the die buttons.

This innovative process uses a series of grooves inside the die button. The slug expands into the grooves, effectively trapping it. This method of controlling slugs is so dependable, it's guaranteed! Test it in your die and we will offer you this unconditional guarantee: **Use Dayton Slug Control in a stamping die now pulling slugs. If for any reason you are not completely satisfied, we will refund the full cost of the Slug Control alteration.** (We cannot guarantee the retention of slugs when clearance exceeds 10% per side.)



Jektole® Punches

Punches

Standard Shapes

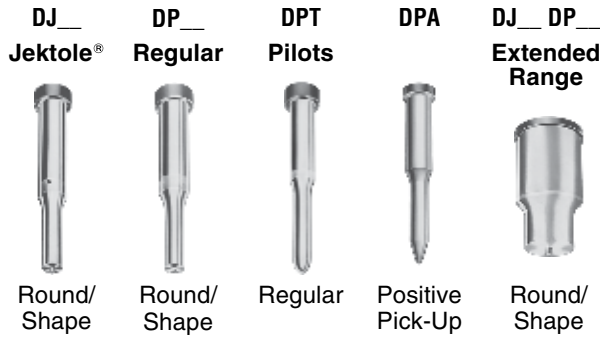
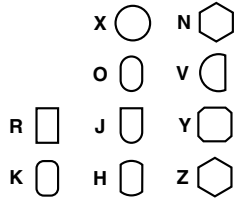

2/3 4/5 6/7 8/9 13

Regular Punches

Regular Pilots

Punches

CloSPACE



60° Square

12

DYX DUX
Straight



Jektole
Regular

10

DJB DPB
Blanks



Jektole
Regular

11

Die Buttons

Solid

EDM Blanks

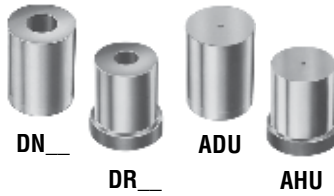

Round/
Shape

14/15

16

Positive Pick-Up Pilots

Straight Punches Punch Blanks

Bushings

Guide Bushings

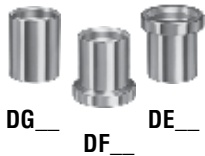

17

Data

Classified Shapes



18/19

Locking Devices

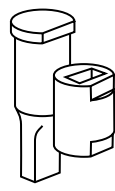

20/21

Jektole Components

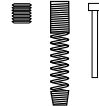

16

CloSPACE Punches Extended Range Punches

Solid Die Buttons

Catalog Ordering System

Significant Catalog System

Example:

DPR Type

D = for Versatile
P = for Punch (Regular)
R = for Rectangle

13 Shank Dia.

25 Point Length L₁

63 Overall Length L

Easy to Specify

The Catalog Designation completely defines the product, including shape, dimensions, tolerances, and concentricity.

How to Order

Specify Qty, Type, Catalog Number, and P or P & W Dimensions

Qty. Type

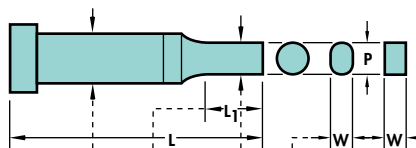

DPR™ 13- 2563 P8.0,W6.5 2 DPO 13 2563 P8.0 W6.5

Type Catalog Number Dimensions As Specified

All Triliteral Designations are a Trademark of Dayton Progress Corporation.

Guide Bushings Jektole Data

Classified Shapes

Locking Devices Form Shapes Treatments and Coatings

Jektol[®] Punches

Precision Ejector Punches

Steel:	HRC
A2, M2	60-63
PS	63-65

All Heads Drawn to HRC 40-55

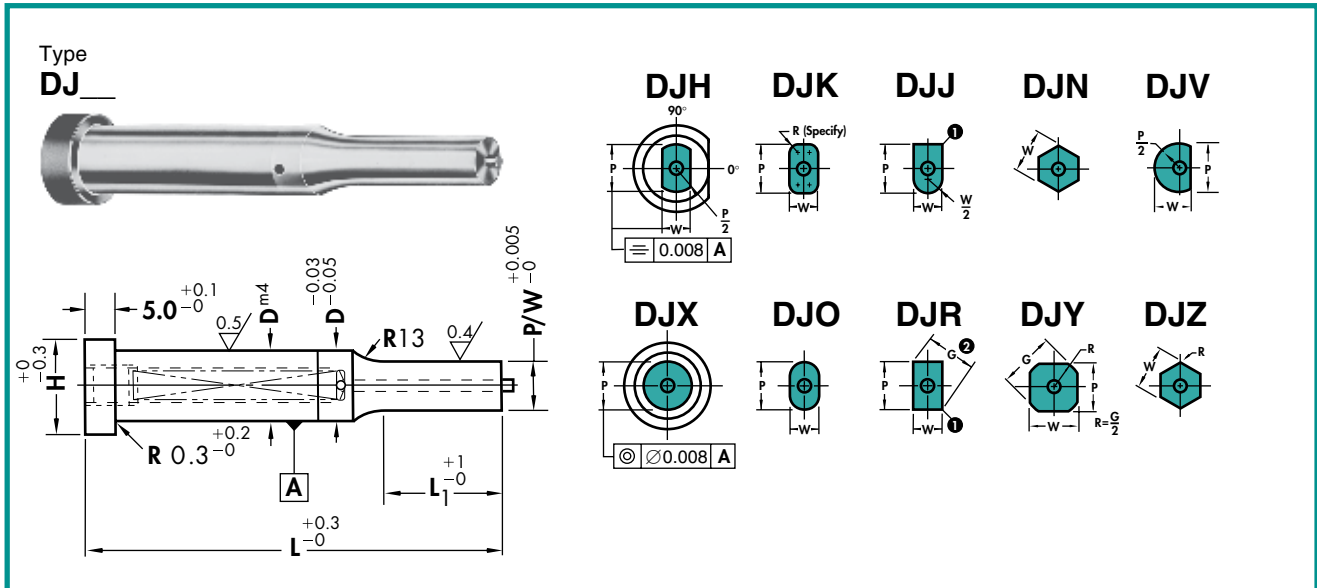

D	H	Point Length L ₁	Type & D DJX	Round Range P	Type & D DJ_	Shape Min. Max. W P/G	L								
							40.0	45.0	50.0	56.0	60.0	63.0	70.0		
05 06	08 09	8.0	DJX 05 DJX 06	1.60- 4.99 2.40- 5.99	DJ_ 05 DJ_ 06	1.60- 5.00 2.40- 6.00	0840	0845	0850	0856	0860	0863	0870		
05 06 08 10 13 16 20 25 32	08 09 11 13 16 19 23 28 35		13.0	DJX 05 DJX 06 DJX 08 DJX 10 DJX 13 DJX 16 DJX 20 DJX 25 DJX 32	1.60- 4.99 2.40- 5.99 3.20- 7.99 4.50- 9.99 6.00-12.99 8.00-15.99 9.50-19.99 12.00-24.99 16.00-31.99	DJ_ 05 DJ_ 06 DJ_ 08 DJ_ 10 DJ_ 13 DJ_ 16 DJ_ 20 DJ_ 25 DJ_ 32	1.60- 5.00 2.40- 6.00 3.20- 8.00 4.50-10.00 6.00-13.00 7.20-16.00 8.00-20.00 9.00-25.00 10.00-32.00		1345	1350	1356	1360	1363	1370	
05 06 08 10 13 16 20 25 32	08 09 11 13 16 19 23 28 35	19.0		DJX 05 DJX 06 DJX 08 DJX 10 DJX 13 DJX 16 DJX 20 DJX 25 DJX 32	1.60- 4.99 2.40- 5.99 3.20- 7.99 4.50- 9.99 6.00-12.99 8.00-15.99 9.50-19.99 12.00-24.99 16.00-31.99	DJ_ 05 DJ_ 06 DJ_ 08 DJ_ 10 DJ_ 13 DJ_ 16 DJ_ 20 DJ_ 25 DJ_ 32	1.60- 5.00 2.40- 6.00 3.20- 8.00 4.50-10.00 6.00-13.00 7.20-16.00 8.00-20.00 9.00-25.00 10.00-32.00		1945	1950	1956	1960	1963	1970	
06 08 10 13 16 20 25 32	09 11 13 16 19 23 28 35			25.0	DJX 06 DJX 08 DJX 10 DJX 13 DJX 16 DJX 20 DJX 25 DJX 32	2.40- 5.99 3.20- 7.99 4.50- 9.99 6.00-12.99 8.00-15.99 9.50-19.99 12.00-24.99 16.00-31.99	DJ_ 06 DJ_ 08 DJ_ 10 DJ_ 13 DJ_ 16 DJ_ 20 DJ_ 25 DJ_ 32	2.40- 6.00 3.20- 8.00 4.50-10.00 6.00-13.00 7.20-16.00 8.00-20.00 9.00-25.00 10.00-32.00				2556	2560	2563	2570

① Sharp corners are typical. To assure proper clearance, Dayton will provide standard broken corners to eliminate interference with die button fillet when total clearance is 0.08 or less.

② Check your P&W dimensions to be sure the diagonal G does not exceed the max shown.

$$G = \sqrt{P^2 + W^2}$$

How to Order:

- Specify: Quantity
- Type
- Shank Diameter
- Point & Overall Length
- P or P & W Dimensions
- Steel
- Standard Alterations

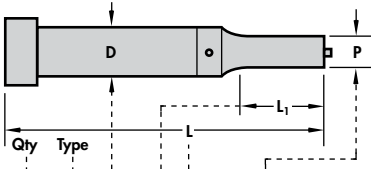

2	DJX08-	1360	P7.25, A2
5	DJX13-	2580	P11.52, M2, XL = 77.5
1	DJR16-	2571	P12.00, W8.00, PS, X2
2	DJK16-	1990	P11.50, W10.50, R1.25, A2, X2

A DAYTON Difference JEKTOLE

The "Triple Your Production" Punch
Retractable Slug Ejector. See page 16.
Pat. No. 2,917,960 and 3,255,654

L				Jektrole Pin
71.0	80.0	90.0	100.0	
0871	0880	0890	08100	J2M J3M
1371	1380	1390	13100	J2M
				J3M
				J4M
				J6M
				J9M
				J9M
1971	1980	1990	19100	J2M
				J3M
				J4M
				J6M
				J9M
				J9M
2571	2580	2590	25100	J3M
				J4M
				J6M
				J6M
				J9M
				J9M
				J12M

Standard Alterations

Standard alterations are the ranges beyond those sizes listed in the catalog which can be manufactured for a slight additional charge.

XP, XW P & W Dimensions Smaller than Standard **XBR** Point Length Longer than Standard

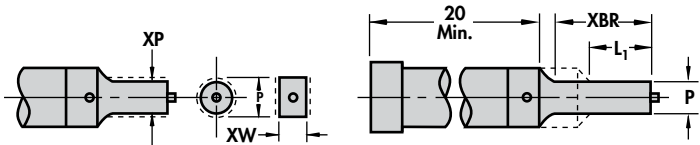

L ₁ Max.	8	13	19	25	30	35	40	8	13	19	25	30	35	Jektrole Pin
Type	D	P Min. (Rounds)						W Min. (Shapes)						
DJ_ 05	1.3	1.3	1.5	2.4	-	-	-	1.6	1.6	1.6	2.4	-	-	J2M
DJ_ 06	2.0	2.0	2.0	2.4	2.5	-	-	2.0	2.0	2.0	2.4	3.0	-	J3M
DJ_ 08	3.0	3.0	3.0	3.0	3.0	3.2	-	3.0	3.0	3.0	3.0	4.0	4.0	J4M
DJ_ 10	4.0	4.0	4.0	4.0	4.0	4.0	6.0	4.0	4.0	4.0	4.0	4.0	4.5	J6M
DJ_ 13	-	4.0	4.0	4.0	4.0	4.0	6.0	-	4.0	4.0	4.0	4.0	4.5	J6M
DJ_ 16	-	6.0	6.0	6.0	6.0	6.0	6.0	-	6.0	6.0	6.0	6.0	6.0	J9M
DJ_ 20	-	6.0	6.0	6.0	7.6	7.6	7.6	-	6.0	6.0	6.0	6.0	6.0	J9M
DJ_ 25	-	8.0	8.0	8.0	10.0	10.0	10.0	-	6.0	6.0	6.0	6.0	6.0	J9M
DJ_ 32	-	10.0	10.0	10.0	10.0	10.0	10.0	-	7.2	7.2	7.2	7.2	7.2	J12M

XD Reduced Shank Diameter
Head Diameter does not change with body diameter.

Shank Dia.	5.0	6.0	8.0	10.0	13.0	16.0	20.0	25.0	32.0
Min. XD	4.4	5.0	6.8	8.8	11.5	14.5	18.5	23.5	30.5

XL Overall Length Shortened (25 min.)
Stock removal from point end which shortens point length. To maintain point length specify "XBR".

XLB Overall Length Shortened
L₁ length maintained (note limits under "XBR")

LL Precision Overall Length
Same as XL except overall length is held to ±0.02

XT Thinner Head than Standard
Stock removal from head end which shortens overall length.

TT Precision Head Thickness
Same as XT except head thickness tolerance is held to ±0.01.

XH Reduced Head Diameter
Minimum head diameter equals D+0.00, -0.03

XLD Alternate Lead Length
The XLD alteration fixes the punch shank length at 40 measured from the punch head. This eliminates pressing the entire shank through the holder.

XK No Side Hole For air ejection. No cost. **XJ** Smaller Jektrole Components See page 13.

Key Flats The standard location for a key flat is Parallel to the P dimension. See pages 20 & 21 for more information.

See page 24 for Surface Treatments and Coatings.

Regular Punches

Precision Non-ejector Punches

Steel:	HRC
A2, M2	60-63
PS	63-65

All Heads Drawn to HRC 40-55

Type DP__

DPH

DPK

DPJ

DPN

DPV

DPX

DPO

DPR

DPY

DPZ

D	H	Point Length L ₁	Type & D	Round	Type & D	Shape	L										
			DPX	Range P	DP_	Min. W	Max. P/G	32.0	40.0	45.0	50.0	56.0	60.0	63.0			
04	07	8.0	DPX 04	1.00- 3.99	DP_ 04	1.60- 4.00											
05	08		DPX 05	1.20- 4.99	DP_ 05	1.60- 5.00											
06	09		DPX 06	1.60- 5.99	DP_ 06	1.60- 6.00	0832	0840	0845	0850	0856	0860	0863				
08	11		DPX 08	2.00- 7.99	DP_ 08	2.00- 8.00											
10	13		DPX 10	2.50- 9.99	DP_ 10	3.20-10.00											
04	07	13.0	DPX 04	1.60- 3.99	DP_ 04	1.60- 4.00											
05	08		DPX 05	1.60- 4.99	DP_ 05	1.60- 5.00											
06	09		DPX 06	1.60- 5.99	DP_ 06	1.60- 6.00											
08	11		DPX 08	2.50- 7.99	DP_ 08	2.50- 8.00											
10	13		DPX 10	3.20- 9.99	DP_ 10	3.20-10.00											
13	16		DPX 13	5.00-12.99	DP_ 13	4.50-13.00			1345	1350	1356	1360	1363				
16	19		DPX 16	8.00-15.99	DP_ 16	6.00-16.00											
20	23		DPX 20	10.00-19.99	DP_ 20	8.00-20.00											
25	28		DPX 25	12.00-24.99	DP_ 25	9.00-25.00											
32	35	DPX 32	16.00-31.99	DP_ 32	10.00-32.00												
04	07	19.0	DPX 04	1.60- 3.99	DP_ 04	1.60- 4.00											
05	08		DPX 05	1.60- 4.99	DP_ 05	1.60- 5.00											
06	09		DPX 06	1.60- 5.99	DP_ 06	1.60- 6.00											
08	11		DPX 08	2.50- 7.99	DP_ 08	2.50- 8.00											
10	13		DPX 10	3.20- 9.99	DP_ 10	3.20-10.00											
13	16		DPX 13	5.00-12.99	DP_ 13	4.50-13.00			1945	1950	1956	1960	1963				
16	19		DPX 16	8.00-15.99	DP_ 16	6.00-16.00											
20	23		DPX 20	10.00-19.99	DP_ 20	8.00-20.00											
25	28		DPX 25	12.00-24.99	DP_ 25	9.00-25.00											
32	35	DPX 32	16.00-31.99	DP_ 32	10.00-32.00												
04	07	25.0	DPX 04	2.50- 3.99	DP_ 04	2.50- 4.00											
05	08		DPX 05	2.50- 4.99	DP_ 05	2.50- 5.00											
06	09		DPX 06	2.50- 5.99	DP_ 06	2.50- 6.00											
08	11		DPX 08	2.50- 7.99	DP_ 08	2.50- 8.00											
10	13		DPX 10	3.20- 9.99	DP_ 10	3.20-10.00											
13	16		DPX 13	5.00-12.99	DP_ 13	4.50-13.00											
16	19		DPX 16	8.00-15.99	DP_ 16	6.00-16.00											
20	23		DPX 20	10.00-19.99	DP_ 20	8.00-20.00											
25	28		DPX 25	12.00-24.99	DP_ 25	9.00-25.00											
32	35	DPX 32	16.00-31.99	DP_ 32	10.00-32.00												

① Sharp corners are typical. To assure proper clearance, Dayton will provide standard broken corners to eliminate interference with die button fillet when total clearance is 0.08 or less.

② Check your P&W dimensions to be sure the diagonal G does not exceed the max shown.

$$G = \sqrt{P^2 + W^2}$$

How to Order:

- Specify: Quantity
 Type
 Shank Diameter
 Point & Overall Length
 P or P & W Dimensions
 Steel
 Standard Alterations

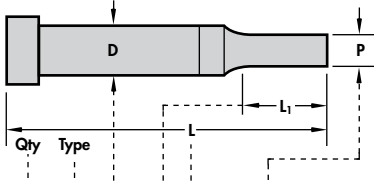

2	DPX10- 0863	P5.00, A2, TT = 5.00
6	DPJ16- 1990	P13.00, W7.00, M2, XBR = 21.0
1	DP032- 25100	P30.00, W16.00, PS, X3 = 90°
2	DPK20- 1956	P15.95, W11.95, R0.95, A2, X2

Standard Alterations

Standard alterations are the ranges beyond those sizes listed in the catalog which can be manufactured for a slight additional charge.

XP, XW P & W Dimensions Smaller than Standard
XBR Point Length Longer than Standard

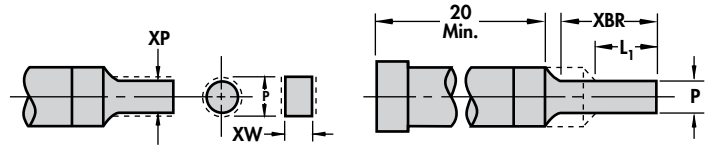

L ₁ Max.	8	13	19	25	30	35	40	8	13	19	25	30	35	
Type D	P Min. (Rounds)							W Min. (Shapes)						
DP_04	.8	1.1	1.3	1.9	2.5	-	-	1.3	1.6	1.6	2.4	2.8	-	
DP_05	1.0	1.3	1.3	1.9	2.5	-	-	1.3	1.6	1.6	2.4	3.0	-	
DP_06	1.3	1.6	1.6	2.0	2.5	-	-	1.3	1.6	1.6	2.4	3.0	-	
DP_08	1.6	1.6	1.6	2.4	2.5	3.2	-	1.6	2.4	2.4	2.4	3.2	4.0	
DP_10	1.6	1.6	1.6	2.5	3.2	3.2	6.0	2.0	2.4	2.8	3.2	3.2	4.0	
DP_13	-	3.2	3.2	3.2	3.2	4.0	6.0	-	3.2	3.2	3.2	3.6	4.5	
DP_16	-	6.0	6.0	6.0	6.0	6.0	6.0	-	6.0	6.0	6.0	6.0	6.0	
DP_20	-	6.0	6.0	6.0	7.6	7.6	7.6	-	6.0	6.0	6.0	6.0	6.0	
DP_25	-	8.0	8.0	8.0	10.0	10.0	10.0	-	6.0	6.0	6.0	6.0	6.0	
DP_32	-	10.0	10.0	10.0	10.0	10.0	10.0	-	6.0	6.0	6.0	6.0	6.0	

XD_{XD}

Reduced Shank Diameter

Head Diameter does not change with body diameter.

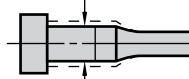

Shank Dia.	4.0	5.0	6.0	8.0	10.0	13.0	16.0	20.0	25.0	32.0
XD Min.	2.5	3.5	4.5	6.5	8.5	11.5	14.5	18.5	23.5	30.5

L					
	70.0	71.0	80.0	90.0	100.0
	0870	0871	0880	0890	08100
	1370	1371	1380	1390	13100
	1970	1971	1980	1990	19100
	2570	2571	2580	2590	25100

XL Overall Length Shortened (25 min.)

Stock removal from point end which shortens point length. To maintain point length specify "XBR".

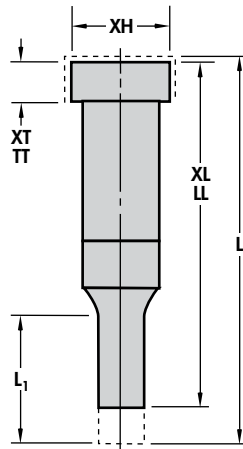

XLB Overall Length Shortened

L₁ length maintained (note limits under "XBR")

LL Precision Overall Length

Same as XL except overall length is held to ±0.02

XT Thinner Head than Standard

Stock removal from head end which shortens overall length.

TT Precision Head Thickness

Same as XT except head thickness tolerance is held to ±0.01.

XH Reduced Head Diameter

Minimum head diameter equals D+0.00, -0.03

XLD Alternate Lead Length

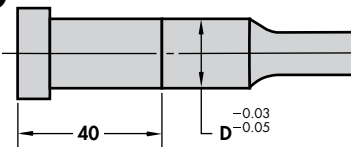

The XLD alteration fixes the punch shank length at 40 measured from the punch head. This eliminates pressing the entire shank through the holder.

Key Flats

The standard location for a key flat is Parallel to the P dimension. See pages 20 & 21 for more information.

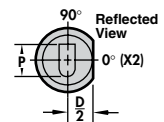

See page 24 for Surface Treatments and Coatings.

Pilots

Precision Pilots
For Stock Control

Steel:	HRC
A2, M2	60-63
PS	63-65

All Heads Drawn to HRC 40-55

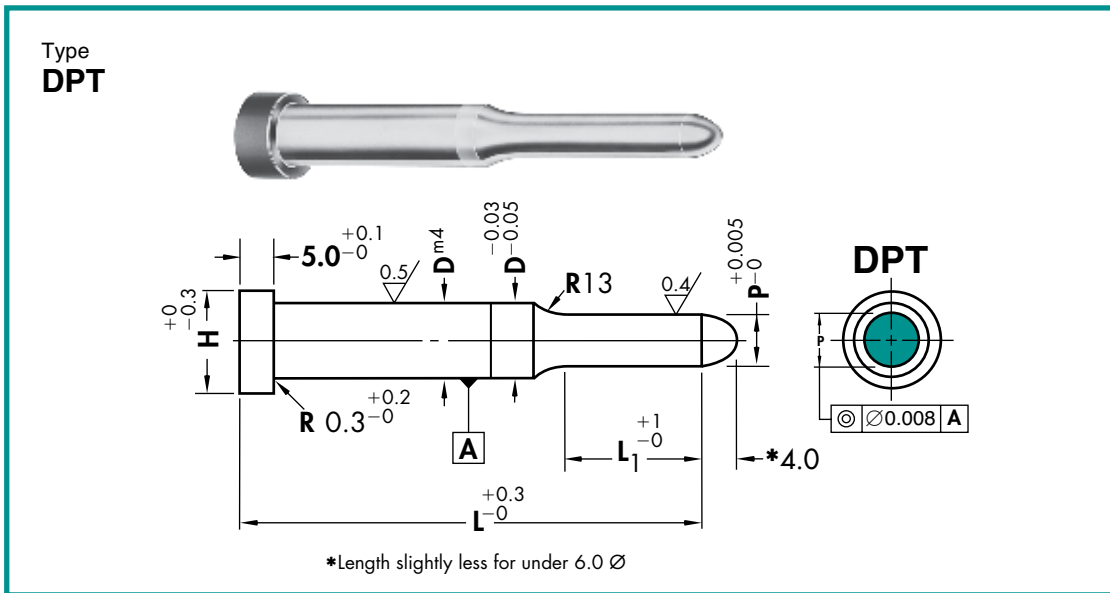

D	H	Point Length L ₁	Type & D DPT	Round Range P	L											
					42.0	47.0	52.0	58.0	62.0	65.0	72.0	73.0	82.0	92.0	102.0	
04	07	10.0	DPT 04	1.55- 4.00												
05	08		DPT 05	1.55- 5.00												
06	09		DPT 06	1.55- 6.00												
08	11		DPT 08	2.35- 8.00												
10	13		DPT 10	2.35-10.00												
04	07	15.0	DPT 04	1.55- 4.00												
05	08		DPT 05	1.55- 5.00												
06	09		DPT 06	1.55- 6.00												
08	11		DPT 08	2.35- 8.00												
10	13		DPT 10	3.15-10.00												
13	16		DPT 13	4.95-13.00		1547	1552	1558	1562	1565	1572	1573	1582	1592	15102	
16	19		DPT 16	7.95-16.00												
20	23		DPT 20	9.95-20.00												
04	07	21.0	DPT 04	1.55- 4.00												
05	08		DPT 05	1.55- 5.00												
06	09		DPT 06	1.55- 6.00												
08	11		DPT 08	2.35- 8.00												
10	13		DPT 10	3.15-10.00												
13	16		DPT 13	4.95-13.00		2147	2152	2158	2162	2165	2172	2173	2182	2192	21102	
16	19		DPT 16	7.95-16.00												
20	23		DPT 20	9.95-20.00												
04	07	27.0	DPT 04	2.45- 4.00												
05	08		DPT 05	2.45- 5.00												
06	09		DPT 06	2.45- 6.00												
08	11		DPT 08	2.45- 8.00												
10	13		DPT 10	3.15-10.00												
13	16		DPT 13	4.95-13.00				2758	2762	2765	2772	2773	2782	2792	27102	
16	19		DPT 16	7.95-16.00												
20	23		DPT 20	9.95-20.00												
04	07	27.0	DPT 04	11.95-25.00												
05	08		DPT 05	15.95-32.00												
06	09		DPT 06													
08	11		DPT 08													
10	13		DPT 10													

How to Order:

- Specify: Quantity
- Type
- Point Length
- Shank Diameter
- Point & Overall Length
- P Dimensions
- Steel
- Standard Alterations

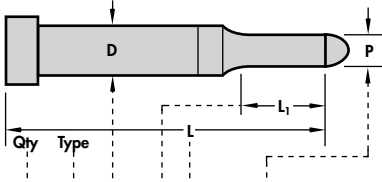

2 DPT10- 1562 P2.90, A2
 5 DPT16- 27102 P10.35, M2, XBR = 32.0

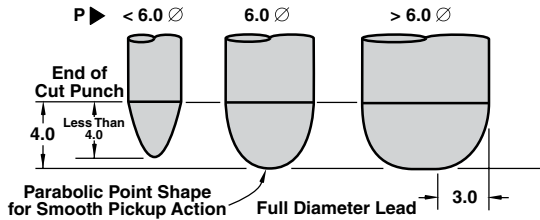

Standard Alterations

Standard alterations are the ranges beyond those sizes listed in the catalog which can be manufactured for a slight additional charge.

XP, XW P & W Dimensions Smaller than Standard

XBR Point Length Longer than Standard

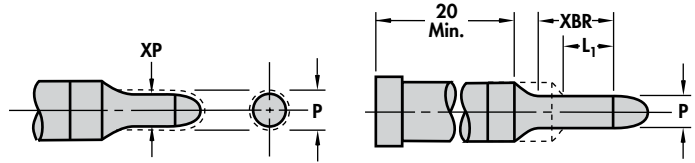

L ₁ Max.	10	15	21	27	32	37	42
Type	P. Min. (Rounds)						
DPT 04	1.55	1.55	1.55	1.85	2.45	-	-
DPT 05	1.55	1.55	1.55	1.85	2.45	-	-
DPT 06	1.55	1.55	1.55	1.95	2.45	-	-
DPT 08	1.55	1.55	1.55	2.35	2.45	3.15	
DPT 10	1.55	1.55	1.55	2.45	3.15	3.15	5.95
DPT 13	-	3.15	3.15	3.15	3.15	3.95	5.95
DPT 16	-	5.95	5.95	5.95	5.95	5.95	5.95
DPT 20	-	5.95	5.95	5.95	7.55	7.55	7.55
DPT 25	-	7.95	7.95	7.95	9.95	9.95	9.95
DPT 32	-	9.95	9.95	9.95	9.95	9.95	9.95

XD

Reduced Shank Diameter

Head Diameter does not change with body diameter.

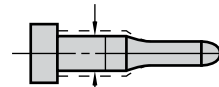

Shank Dia.	4.0	5.0	6.0	8.0	10.0	13.0	16.0	20.0	25.0	32.0
Min. XD	2.5	3.5	4.5	6.5	8.5	11.5	14.5	18.5	23.5	30.5

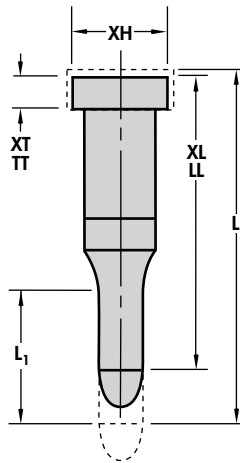

XL

Overall Length Shortened (25 min.)

Stock removal from point end which shortens point length. To maintain point length specify "XBR".

XLB

Overall Length Shortened

L₁ length maintained (note limits under "XBR")

XT

Thinner Head than Standard

Stock removal from head end which shortens overall length.

TT

Precision Head Thickness

Same as XT except head thickness tolerance is held to ±0.01.

XH

Reduced Head Diameter

Minimum head diameter equals D+0.00, -0.03

XLD Alternate Lead Length

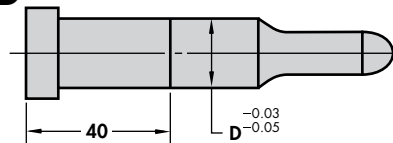

The XLD alteration fixes the punch shank length at 40 measured from the punch head. This eliminates pressing the entire shank through the holder.

See page 24 for Surface Treatments and Coatings.

Positive Pick-Up Pilots

Steel:	HRC
M2	60-63

All Heads Drawn to HRC 40-55

Precision Pilots
For Greater Stock Movement

Order any length from
62 through 142mm.

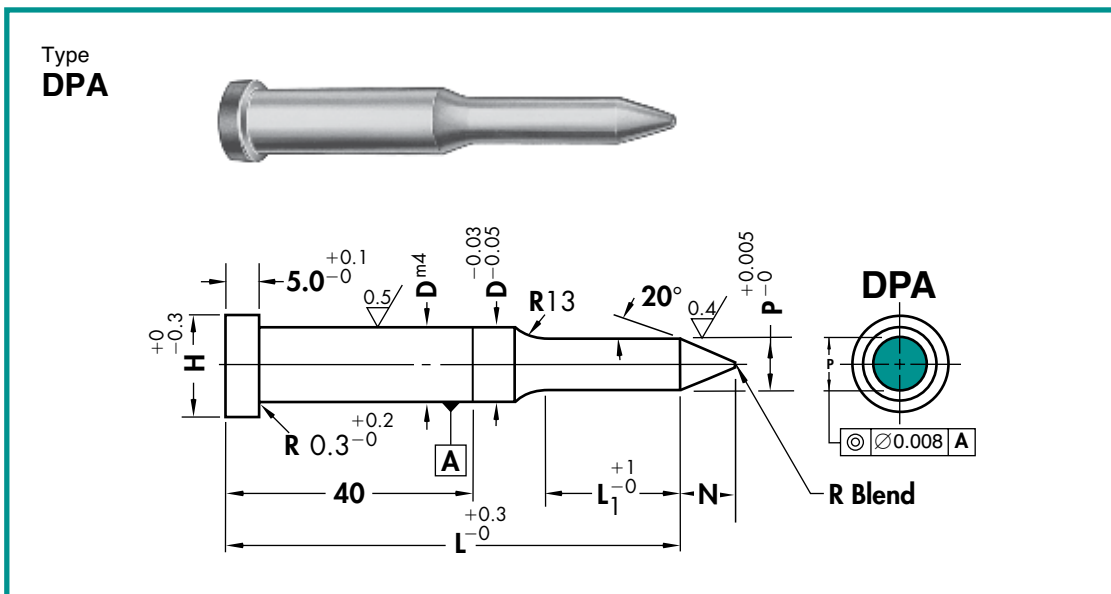

D	H	Point Length L ₁	Type & D	Round	Nose Length N	L										
			DPA	Range P		62.0	65.0	72.0	73.0	82.0	92.0	102.0	112.0	127.0	142.0	
10	13	21.0	DPA 10	4.85-10.00	8.0											
13	16		DPA 13	6.30-13.00	10.0	2162	2165									
16	19		DPA 16	9.95-16.00	15.0			2172	2173	2182	2192	21102	21112	21127	21142	
20	23		DPA 20	13.60-20.00	20.0											
25	28		DPA 25	17.25-25.00	25.0											
32	35		DPA 32	20.85-32.00	30.0											
10	13	27.0	DPA 10	4.85-10.00	8.0											
13	16		DPA 13	6.30-13.00	10.0	2762	2765									
16	19		DPA 16	9.95-16.00	15.0			2772	2773	2782	2792	27102	27112	27127	27142	
20	23		DPA 20	13.60-20.00	20.0											
25	28		DPA 25	17.25-25.00	25.0											
32	35		DPA 32	20.85-32.00	30.0											
32	35	32.0	DPA 32	20.85-32.00	30.0			3272	3273	3282	3292	32102	32112	32127	32142	

When P = D shank tolerance applies to full length.

How to Order:

- Specify: Quantity
- Type
- Point Length
- Shank & Length Codes
- P Dimensions
- Steel
- Standard Alterations

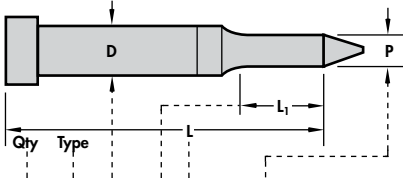

6 DPA 13- 27112 P12.90, XL = 105.0

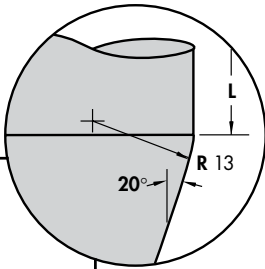

Geometry provides smoother pick up without risk of distortion of hole.

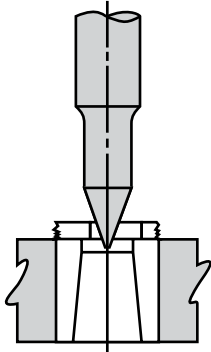

Greater Positioning—moves stock further than conventional pilots

Standard Alterations

Standard alterations are the ranges beyond those sizes listed in the catalog which can be manufactured for a slight additional charge.

XP, XW P & W Dimensions Smaller than Standard

XBR Point Length Longer than Standard
Specify XBR or XBB and length (see chart)

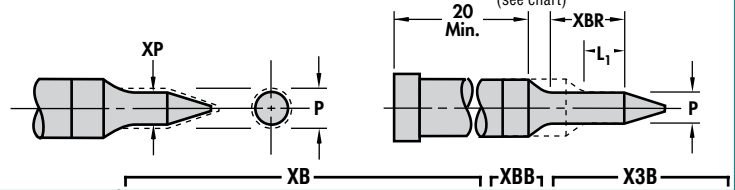

L ₁ Max.		10	15	21	27	32	37	42	50	60	70
Type	Code	Min. P (Rounds)									
DPA	10	2.10	2.10	2.10	2.10	3.15	3.15	5.95	5.95	5.95	7.95
DPA	13	—	3.15	3.15	3.15	3.15	3.95	5.95	5.95	5.95	7.95
DPA	16	—	5.95	5.95	5.95	5.95	5.95	5.95	5.95	5.95	7.95
DPA	20	—	5.95	5.95	5.95	7.55	7.55	7.55	7.55	7.55	7.95
DPA	25	—	7.95	7.95	7.95	9.95	9.95	9.95	9.95	9.95	9.95
DPA	32	—	9.95	9.95	9.95	9.95	9.95	9.95	9.95	9.95	9.95

XBB & X3B add 3 days to delivery

XD

Reduced Shank Diameter

Head Diameter does not change with body diameter.

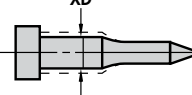

Shank Dia.	10.0	13.0	16.0	20.0	25.0	32.0
Min. XD	8.5	11.5	14.5	18.5	23.5	30.5

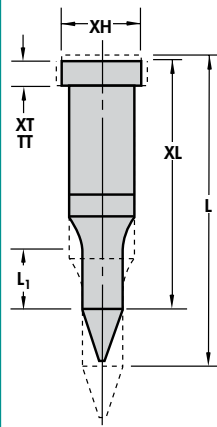

XL Overall Length Shortened (25mm min.)
Stock removal from point end standard L₁ length maintained.

XT Thinner Head than Standard
Stock removal from head end which shortens overall length.

TT Precision Head Thickness
Same as XT except head thickness tolerance is held to ±0.01.

XH Reduced Head Diameter
Minimum head diameter equals D +0.00, -0.03.

See page 24 for Surface Treatments and Coatings.



Straight Punches

Jektole® & Regular

How to Order:

Specify: Quantity
Type
Length Codes
P Dimension
Steel
Standard Alterations

2 DYX 56 P6.005, A2
5 DUX 70 P9.50, M2

Steel:	HRC
A2, M2	60-63

All Heads Drawn to HRC 40-55

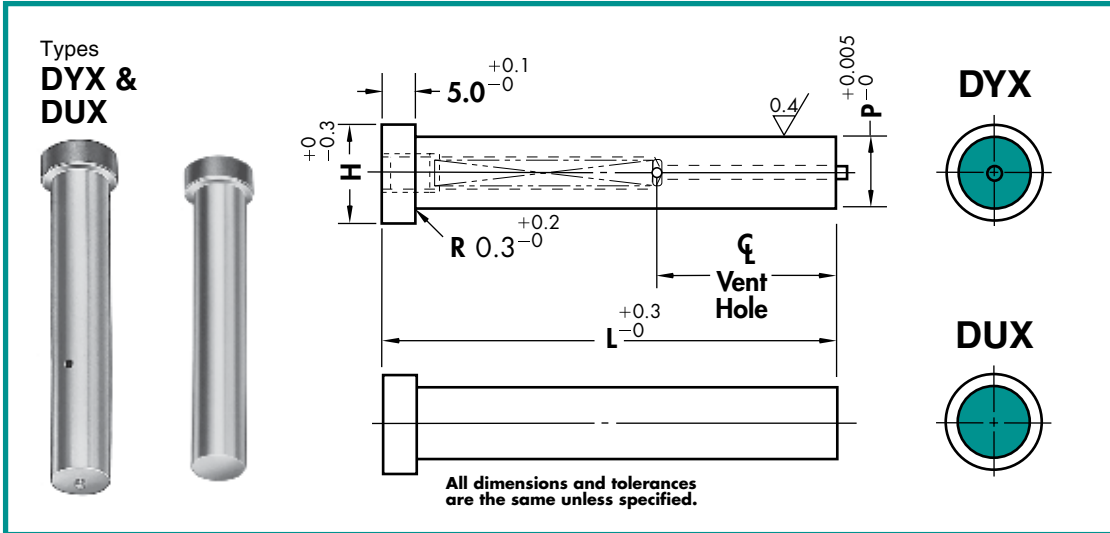

Type	Range P	H	φ Vent Hole	L											Jektole Pin	
				32.0	40.0	45.0	50.0	56.0	60.0	63.0	70.0	71.0	80.0	90.0		100.0
DYX	5.000- 6.000	9.0	14.0	32	40	45	50	56								J2M
	6.001- 8.000	11.0	14.0	32	40	45										J3M
			21.3				50	56	60	63	70	71	80		J3M	
	8.001-10.000	13.0	15.2	32	40	45										J4M
			22.5				50	56	60	63	70	71	80	90		J4M
10.001-13.000	16.0	22.5				40	45	50	56						J6M	
		27.9						60	63	70	71	80	90		J6M	
DUX	3.000- 4.000	7.0	N/A												N/A	
	4.001- 5.000	8.0														
	5.001- 6.000	9.0														
	6.001- 8.000	11.0		32	40	45	50	56	60	63	70	71	80	90		100
	8.001-10.000	13.0														
10.001-13.000	16.0															
13.001-16.000	19.0															

Standard alterations

Standard alterations are the ranges beyond those sizes listed in the catalog which can be manufactured for a slight additional charge.

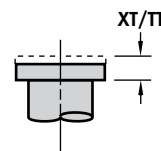
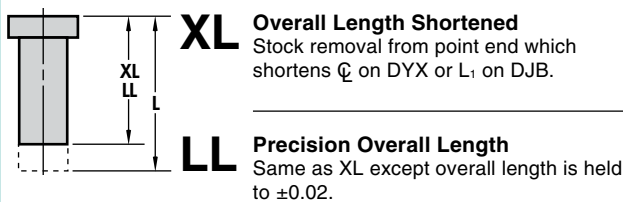

XT Thinner Head than Standard
Stock removal from head end which shortens overall length.

TT Precision Head Thickness
Same as XT except head thickness tolerance is held to ±0.01.

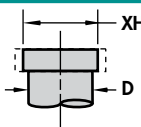

XH Reduced Head Diameter
Minimum head diameter equals D+0.00, -0.03.

Alterations apply to Straight Punches & Blanks.

Punch Blanks

Jektole® & Regular

How to Order:

Specify: Quantity
Type
Shank & Length Codes
Steel

4 DJB 10-2571 M2
3 DPB 06-63 PS

Steel:	HRC
A2, M2	60-63
PS	63-65

All Heads Drawn to HRC 40-55

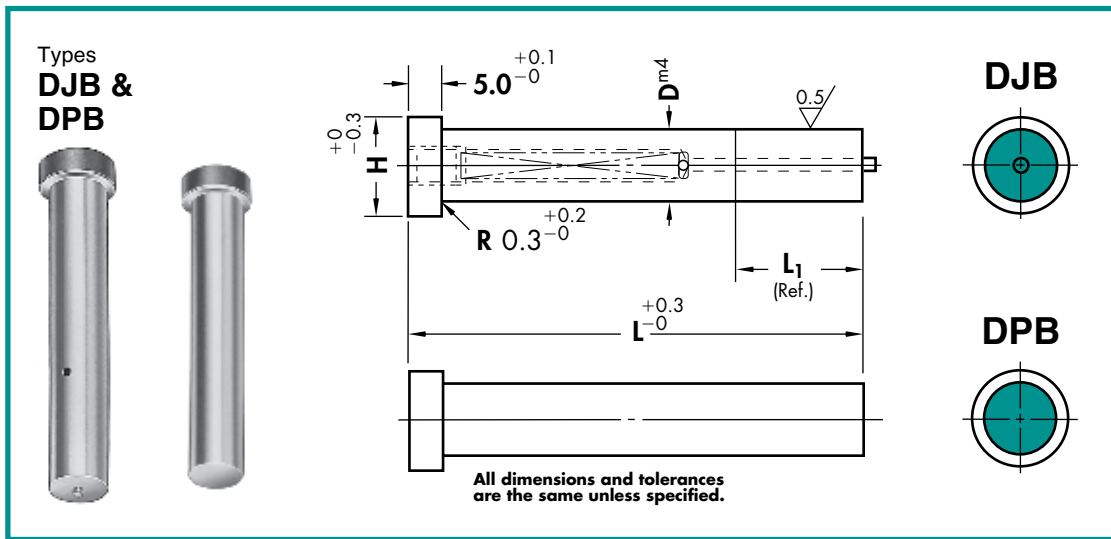

D	H	Point Length L ₁ (Ref.)	Type & D	L												Jektole Pin		
				D_B	32.0	40.0	45.0	50.0	56.0	60.0	63.0	70.0	71.0	80.0	90.0		100.0	
05	8.0	13.0	DJB 05														J2M	
06	9.0		DJB 06		<i>0840</i>													J3M
08	11.0		DJB 08															J4M
10	13.0		DJB 10															J6M
13	16.0		DJB 13				1345	1350	1356	1360	1363	1370	1371	1380	1390	13100		J6M
16	19.0		DJB 16															J9M
20	23.0		DJB 20															J9M
25	28.0		DJB 25															J9M
32	35.0		DJB 32															J12M
05	8.0		25.0	DJB 05														J2M
06	9.0	DJB 06															J3M	
08	11.0	DJB 08															J4M	
10	13.0	DJB 10															J6M	
13	16.0	DJB 13					1945	1950	2556	2560	2563	2570	2571	2580	2590	25100		J6M
16	19.0	DJB 16																J9M
20	23.0	DJB 20																J9M
25	28.0	DJB 25																J9M
32	35.0	DJB 32								1960								J12M
04	7.0	As Req'd		DPB 04														N/A
05	8.0		DPB 05															
06	9.0		DPB 06															
08	11.0		DPB 08															
10	13.0		DPB 10															
13	16.0		DPB 13	32	40	45	50	56	60	63	70	71	80	90	100			
16	19.0		DPB 16															
20	23.0		DPB 20															
25	28.0		DPB 25															
32	35.0		DPB 32															

Max. SBR 8 and 19 are indicated by Italics.

CloSPACE Punches

For Precision,
Close Space Holes

Steel:	HRC
A2, M2	60-63

DCX, DXX, DCB Heads
Drawn to HRC 40-55

How to Order:

Specify: Quantity
Type
Point Length
Shank & Length Codes
P Dimension
Steel
Standard Alterations

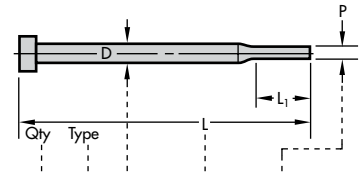

5	DCX04-	071	P3.49, A2
8	DWX	80	P5.00, M2
5	DCB06-	70	M2

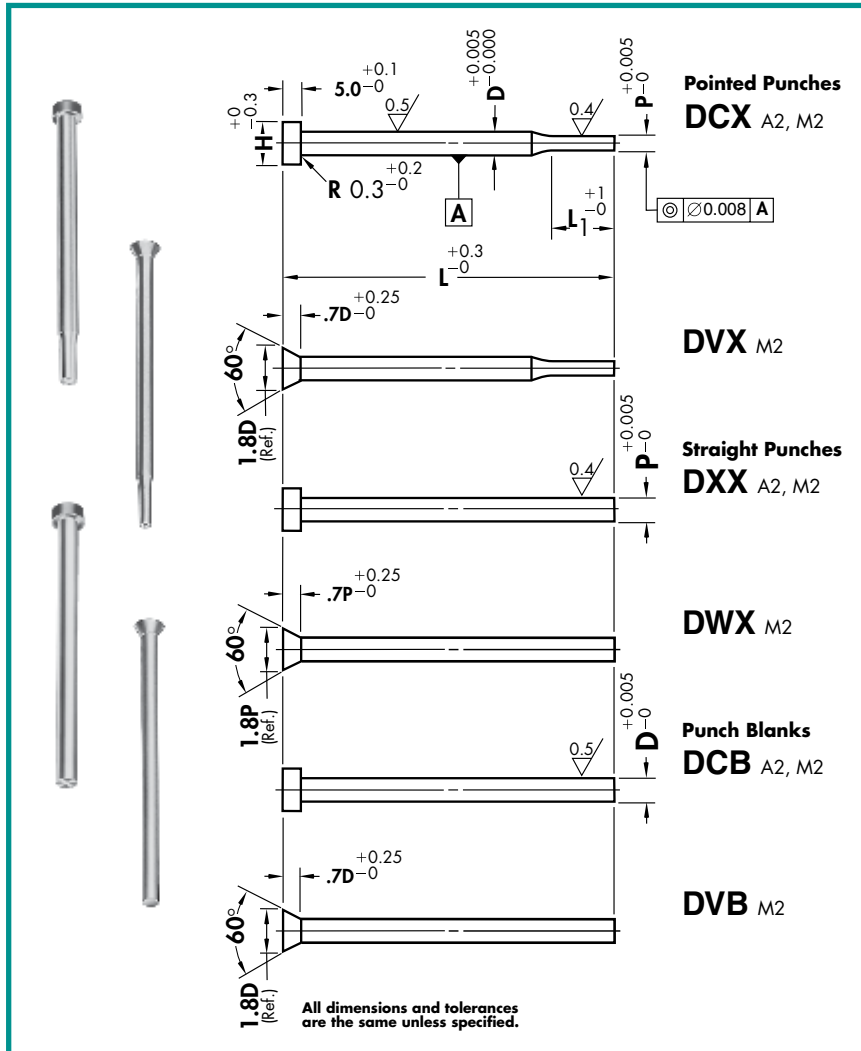

CloSPACE Punch Alterations

See page 5 for an explanation of these alterations.

Product	DXX DWX			
	DCB	DVB	DCX	DVX
XBR			•	•
XD			•	
XH	•		•	
XL	•	•	•	•
LL	•	•	•	•
XP			•	•
XT	•		•	
TT	•		•	
XN*	•	•	•	•
XNT*	•	•	•	•

*Available on M2 only.

Type	Body D	Head Dia. H	Point Length L ₁	Range P	L									
					40.0	45.0	50.0	56.0	60.0	63.0	70.0	71.0	80.0	
DCX DVX Regular Punches	2.0	4.0	5.0	0.81-2.00										
	3.0	5.0	7.0	2.01-3.00										
	4.0	6.0	8.0	3.01-4.00	40	45	50	56	60	63	70	71	80	
	5.0	7.0	8.0	4.01-5.00										
	6.0	8.0	8.0	5.01-6.00										
	7.0	9.0	8.0	6.01-7.00										
DXX DWX Straight Punches	N/A	3.0	N/A	0.81-1.60										
	N/A	4.0	N/A	1.61-2.00										
	N/A	5.0	N/A	2.01-3.00										
	N/A	6.0	N/A	3.01-4.00	40	45	50	56	60	63	70	71	80	
	N/A	7.0	N/A	4.01-5.00										
	N/A	8.0	N/A	5.01-6.00										
DCB DVB Punch Blanks	2.0	4.0	N/A	N/A										
	3.0	5.0	N/A	N/A										
	4.0	6.0	N/A	N/A										
	5.0	7.0	N/A	N/A	40	45	50	56	60	63	70	71	80	
	7.0	9.0	N/A	N/A										

Extended Range Punches

Jektole® & Regular
For Larger Dia. Holes

How to Order:

Specify: Quantity
Type
Shank Diameter
Point & Overall Length
P or P & W Dimensions
Steel

Steel:	HRC
A2	60-63

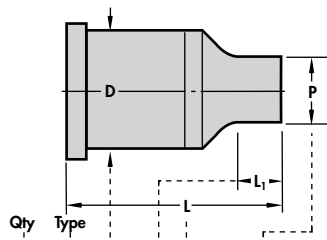

2 DJX40- 2580 P38.5
5 DPR50-30100 P38.0, W24.5, X3
4 DJK63- 1971 P55.75, W15.75, R1.75, X2

Type DJ

Type DP

D_H

D_K

D_J

D_N

D_V

D_X

D_O

D_R

D_Y

D_Z

Type	Shank D	H	Point Length L ₁	Round	Shape	L										
				Range P	Min. W	Max. P/G	60.0	63.0	70.0	71.0	80.0	90.0	100.0			
DJ DP	40.0	43.0	19.0	20.00-40.00	8.00-40.00											
	45.0	48.0		25.00-45.00	9.00-45.00											
	50.0	53.0		30.00-50.00	10.00-50.00	1960	1963	1970	1971	1980	1990	19100				
	56.0	59.0		35.00-56.00	11.00-56.00											
	63.0	66.0		40.00-63.00	12.00-63.00											
	40.0	43.0	25.0	20.00-40.00	8.00-40.00											
	45.0	48.0		25.00-45.00	9.00-45.00											
	50.0	53.0		30.00-50.00	10.00-50.00			2563	2570	2571	2580	2590	25100			
	56.0	59.0		35.00-56.00	11.00-56.00											
	63.0	66.0		40.00-63.00	12.00-63.00											
	40.0	43.0	30.0	20.00-40.00	8.00-40.00											
	45.0	48.0		25.00-45.00	9.00-45.00											
	50.0	53.0		30.00-50.00	10.00-50.00											
	56.0	59.0		35.00-56.00	11.00-56.00											
	63.0	66.0		40.00-63.00	12.00-63.00					3070	3071	3080	3090	30100		

1 Sharp corners are typical. To assure proper clearance, Dayton will provide standard broken corners to eliminate interference with die button fillet when total clearance is 0.08 or less.

2 Check your P & W dimensions to be sure the diagonal G does not exceed the max shown.

$$G = \sqrt{P^2 + W^2}$$

Die Buttons

Precision
Headed & Headless

Die Button Construction

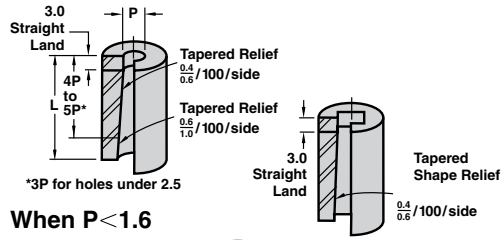

Steel:	HRC
A2, M2	60-63
PS	63-65

When $P < 1.6$

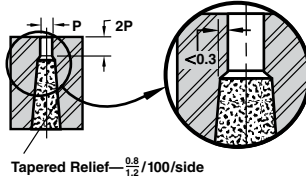

Type
DR_



Type
DN_



DR_ Headed

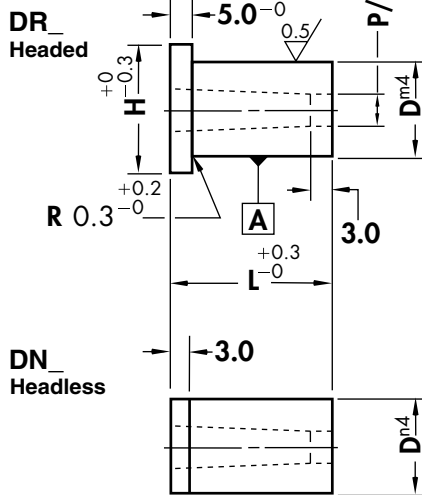

DN_ Headless

All dimensions and tolerances are the same unless specified.

D_H

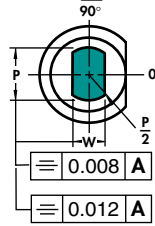

D_K

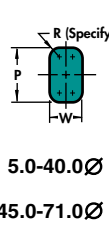

D_J

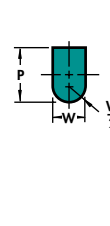

D_N



D_V

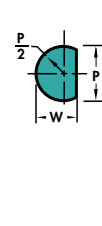

D_X

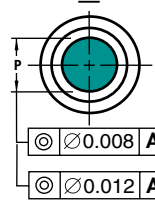

D_O

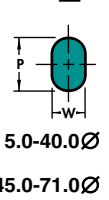

D_R

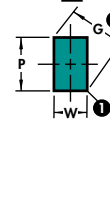

D_Y

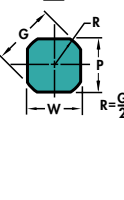

D_Z

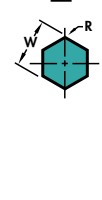

Type	Body D	H	Round	Shape	L										
			Range P	Min. Max. W P/G	13.0	16.0	20.0	22.0	25.0	28.0	30.0	32.0	35.0	40.0	
DN_ DR_	5.0	8.0	1.60- 3.20	1.30- 3.20											
	6.0	9.0	1.60- 3.90	1.30- 3.90											
	8.0	11.0	2.40- 5.40	1.30- 5.40	13	16	20	22	25	28					
	10.0	13.0	3.20- 6.80	1.30- 6.80							30	32	35		
	13.0	16.0	5.40- 8.80	1.90- 8.80											
DN_ DR_	16.0	19.0	7.40-10.80	1.90-10.80											
	20.0	23.0	9.50-13.60	1.90-13.60											
	25.0	28.0	12.00-17.00	1.90-17.00											
	32.0	35.0	16.00-22.00	1.90-22.00			20	22	25	28	30	32	35		
	38.0	41.0	18.00-27.00	1.90-27.00											
	40.0	43.0	18.00-27.00	1.90-27.00											
DN_ Only	45.0		18.00-35.00	4.80-35.00											
	50.0		18.00-40.00	4.80-40.00											
	56.0		18.00-45.00	4.80-45.00											
	63.0		18.00-50.00	4.80-50.00				22	25	28	30	32	35	40	
	71.0		18.00-56.00	4.80-56.00											

45.0 through 71.0 D available
A2 and M2 only.

① 0.2 Max. Fillet (Typical)

② Check your P & W dimensions to be sure the diagonal G does not exceed the max. shown.

$$G = \sqrt{P^2 + W^2}$$

How to Order:

Specify: Quantity
 Type
 Body Dia. & Length Codes
 P or P&W Dimensions
 Steel
 Standard Alterations

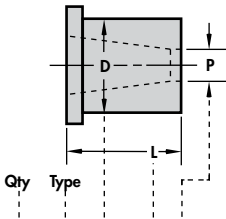

2 DNX50- 25 P37.92, M2, XD = 49.99
 5 DNX13- 35 P8.00, W2.15, A2, XB = 2.00
 2 DRK20- 32 P12.02, W6.02, R0.52, A2

Shortened Die Button Land

To minimize slug jamming in the die button, the land length should be shortened for stock thicknesses less than 0.80. The shorter land lengths are available at no extra charge but must be specified.

Stock Thickness T	Recommended Land Length XB
0.10-0.30	0.8
0.30-0.50	1.6
0.50-0.80	2.4
0.80-up	3.0

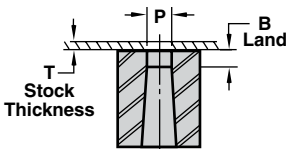

Example: T=0.40

DNX 05-25, P2.60, M2, XB1.6

Dayton Slug Control is Easy to Order

Dayton Slug Control is as easy as specifying a catalog number. Add the information that is unique to your application to the die button catalog number. See the example below:

You must specify **XSC** for alteration, **material thickness** and **clearance per side** as a percent.

Catalog Number			Your Specs		
DNX	16-25	P6.3	XSC	MM1.0	CS5
Type	D L	P	Alteration Code	Material Thickness (mm)	Clearance Per Side (%)

This information will be entered into our computer to generate a program to alter the land of the die button and end your slug pulling problems forever!

See inside front of catalog for more information.

Key Flats

The standard location for a key flat is Parallel to the P dimension. See pages 20 & 21 for more information.

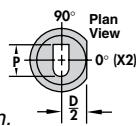

Standard Alterations

Standard alterations are the ranges beyond those sizes listed in the catalog which can be manufactured for a slight additional charge.

XP, XW P & W Dimensions Larger than Standard

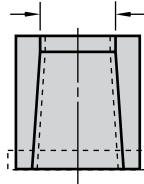

Body Code	Max P/G	Body Code	Max P/G
5.0	3.20	16.0	12.80
6.0	4.00	20.0	16.00
8.0	6.20	25.0	20.00
10.0	7.70	32.0	25.60
13.0	10.40	40.0	32.00

XB Land Length Shorter or Longer than Standard

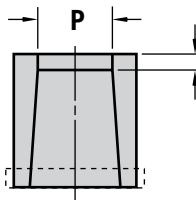

Hole Range	Max XB*
0.800- 1.600	3.2
1.601- 2.400	5.0
2.401- 4.000	6.0
4.001- 6.000	8.0
6.001- 8.000	9.5
8.001-10.000	11.0
10.001-over	13.0

* No max XB on shaped dies

XD Reduced Body Dia.

Head Diameter does not change with body reduction.

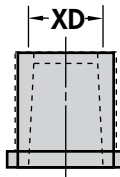

Body Code	Min XD	Max P/G	Body Code	Min XD	Max P/G
5.0	3.500	.72D	16.0	14.500	.80D
6.0	5.000	.75D	20.0	18.500	.80D
8.0	6.500	.77D	25.0	23.000	.80D
10.0	8.500	.80D	32.0	30.000	.80D
13.0	11.500	.80D	38.0	36.000	.80D
			40.0	38.000	.80D

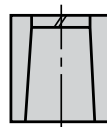

XSC Slug Control eliminates slug pulling. (See order example at left.)

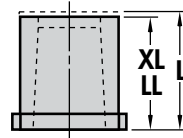

XL Overall Length Shortened

Minimum overall length:
 Headless = 6.35
 Headed = 6.35 + T

LL Precision Overall Length

Same as XL except overall length is held to ±0.02.

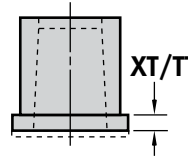

XT Thinner Head than Standard

Stock removal from Head end which shortens overall length.

TT Precision Head Thickness

Same as XT except head thickness is held to ±0.01.

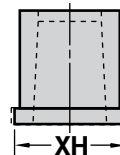

XH Reduced Head Diameter

Minimum head diameter equals D + 0.00 -0.03.

XAR Increased Taper Relief (10° per side max)

Standard B length unless XB is specified. Default angle is 1° when an angle is not specified.

Min. P or W
1.3mm

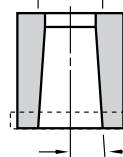

XBL Straight Through Land

The land length (B) equals the overall length of the die button. Can be used for bushings, guides and a variety of other applications. Round only.

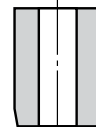

XN DayTride® a unique wear resistant surface treatment for M2 & PS only.

XNT DAYTIN® Titanium Nitride coating for extra wear. For M2 & PS only.



EDM Die Button Blanks

Steel:	HRC
A2, M2	60-63

How to Order:

Specify: Quantity
Type
Body Dia. & Length Codes
P Dimensions

8 AHU 45-40
2 ADU 13-30 XP2.0

For the fastest delivery use the hole (P) dimensions given in the chart. If another hole is desired, simply specify "XP" and give the dimension.

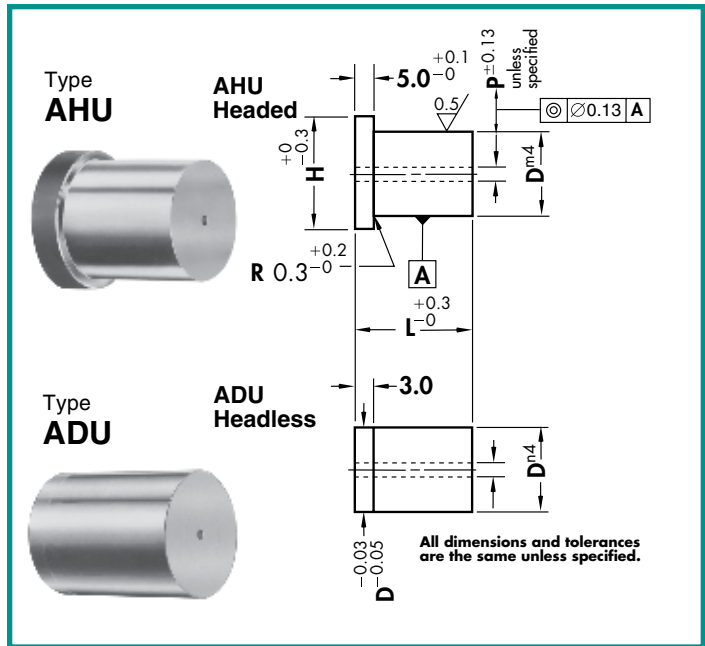

Type	Body D	H	P	L											
				13.0	16.0	20.0	22.0	25.0	28.0	30.0	32.0	35.0	40.0		
ADU AHU	5.0	8.0	0.8												
	6.0	9.0	0.8												
	8.0	11.0	0.8	13	16	20	22	25	28						
	10.0	13.0	0.8							30	32	35			
	13.0	16.0	1.6												
ADU AHU	16.0	19.0	1.6												
	20.0	23.0	1.6												
	25.0	28.0	1.6			20	22	25	28	30	32	35			
	32.0	35.0	1.6												
	38.0	41.0	1.6												
ADU Only	40.0	43.0	1.6												
	45.0		3.2												
	50.0		3.2												
	56.0		3.2												
ADU Only	63.0		3.2												
	71.0		3.2												
							22	25	28	30	32	35	40		

Jektole® Data

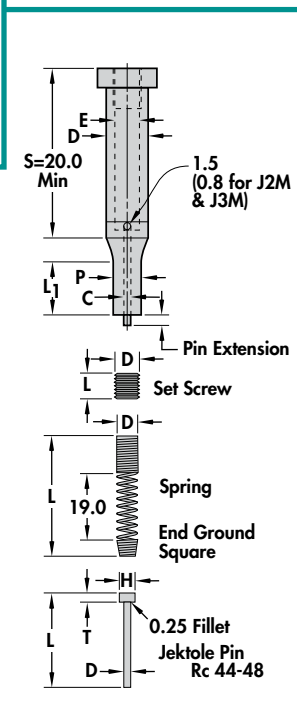

The Key to Increased Productivity

Jektole In Production

- Requires less press tonnage
- Reduces pressure required to strip the punch ... which in turn reduces punch wear
- Produces minimal burr
- Doubles (and often triples) piece output per grind
- Reduces total punch costs

Jektole In Maintenance

- Keeper Key — holds pin in retracted position
- Eliminates the need for disassembly before grinding
- Maintains proper pin extension
- Reduces downtime for re-grinding

Standard Jektole Data

DIMENSION	J2M	J3M	J4M	J6M	J9M	J12M
Std. Shank Dia. D	5.0	6.0	8.0	10.0	16.0	32.0
Point Hole Dia. C	0.5	0.8	1.2	1.6	2.4	3.2
Shank Hole Dia. E	2.2	2.5	3.4	4.4	5.2	7.0
Pin Extension	0.8	0.8	1.6	1.6	1.6	1.6

Jektole Design Limits

DIMENSION	J2M	J3M	J4M	J6M	J9M	J12M
Min. Shank Dia. D	4.4	5.0	6.8	8.8	10.4	14.0
Min. Point Dia. P	1.3	2.0	3.0	4.0	6.0	7.2
Max. Point Lgth.	32.0	38.0	41.0	41.0	41.0	41.0
Max. Shank Lgth. S	87.0	87.0	84.0	84.0	84.0	70.3

Universal Jektole Components

EJECTOR PINS		J2M	J3M	J4M	J6M	J9M	J12M
Overall Length L		28.0	35.0	49.0	49.0	56.5	56.5
Pin Diameter D		0.43	0.68	1.04	1.47	2.26	3.05
Head Diameter H		1.2	1.8	2.4	3.0	4.0	4.8
Head Thickness T		0.8	1.2	1.6	1.6	2.4	2.4
SPRINGS		J2M	J3M	J4M	J6M	J9M	J12M
Outside Dia. D		2.05	2.40	3.25	4.25	5.00	6.90
Free Length L		60.3	60.3	81.0	76.2	68.9	65.1
Pressure (Pre-Load)	Newtons	2.2	3.3	4.5	6.7	9.0	11.3
SCREWS		J2M	J3M	J4M	J6M	J9M	J12M
Screw Size D		M2.6	M3	M4	M5	M6	M8
Screw Length L		5.0	5.0	5.0	5.0	6.0	6.0

Guide Bushings

Land Length V

P	V
0.800-1.700	2P
1.701-2.400	P + 1.7
2.401-10.800	.82P + 2.1

Steel:	HRC
A2	60-63

Applies to all products on this page

For Punch Point Support

Guide Bushing Alterations

Product	Round	Shape
XH	•	•
XP	•	•
XT	•	•
TT	•	•

See page 15 for an explanation of these alterations.

How to Order:

Specify: Quantity
 Type
 Body & Length Codes
 P or P & W Dimensions
 Steel
 Standard Alterations

4 DEX06-13 P2.00, XH = 7.00
 2 DFO10-10 XP7.00, W2.90, A2
 3 DGK16-16 P6.60, W6.10, R1.00, A2

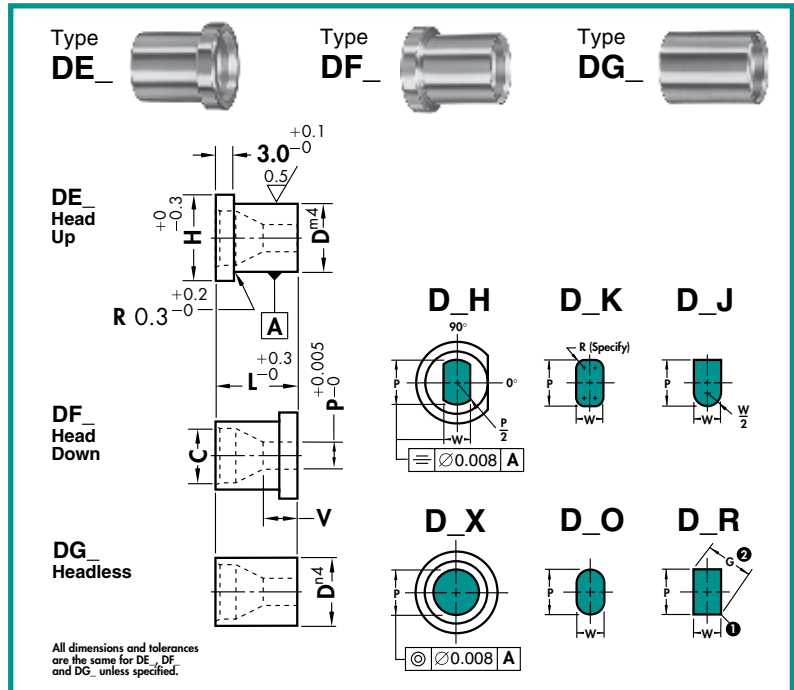

Type	Body D	H	Round	Shape	C' Bore Dia. C	L			
			Range P	Min. W		Max. P/G	8.0	10.0	13.0
DG_ Headless	5.0	8.0	1.60- 3.20	1.30- 3.20	3.6	8			
DF_ Head Down	6.0	9.0	1.60- 3.90	1.30- 3.90	4.6		10		
DE_ Head Up	8.0	11.0	2.40- 5.40	1.30- 5.40	6.6			13	
	10.0	13.0	3.20- 6.80	1.30- 6.80	8.2				16
	13.0	16.0	5.40- 8.80	1.90- 8.80	11.4				
	16.0	19.0	7.40-10.80	1.90-10.80	Cone complet				

① 0.2 Max. Fillet (Typical)

② Check your P & W dimensions to be sure the diagonal G does not exceed the max. shown.

$$G = \sqrt{P^2 + W^2}$$



Classified Shapes

- Simplified Specification
- 83 Common Shapes
- No Detailing Required

Views

Views are... Reflected View of Punch and Guide, Plan View of Die Button... see opposite column.

Orientation and Locking

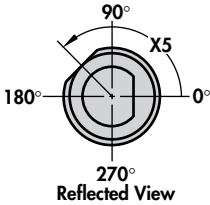

The Locking Device orientation is standard at 0°. For types of locking methods and custom locations see pages 20 and 21.

Clearance

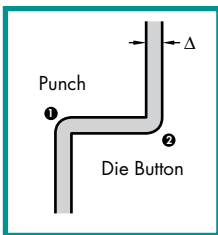

Notes ① and ② — Fillets and Sharp Corners
Normal gridding methods produce:
① 0.2 max fillet on the punch... matching corner sharp on the die button.
② 0.2 max fillet on the die button... matching corner sharp on the punch.

Fillets matched with sharp corners reduces the clearance per side (Δ) If the clearance is 0.04 Δ or less, Dayton will break sharp corners when the punches and/or guides and die buttons are ordered together. This reduces assembly time and the risk of edge breaking during operation.

+ Shape Center

Shapes are centered on punch shanks as shown. Shapes in guide bushings and die buttons are also centered as shown with the exception of shapes C22 and C34. Due to clearance, the P dimension on these shapes will not be centered.

* Corner Dimensions

Dimensions should be to the theoretical sharp corners for shapes C22, C24, C25, C34, C61 and C88. Some reduction of these dimensions will result from fitting the punch and die button under conditions where clearance is 0.04 or less per side.

Flatted Rounds

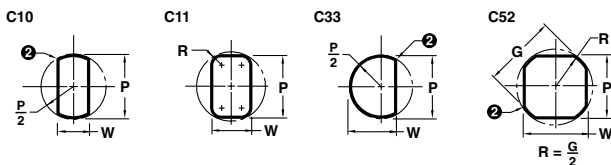

Multi-lobes

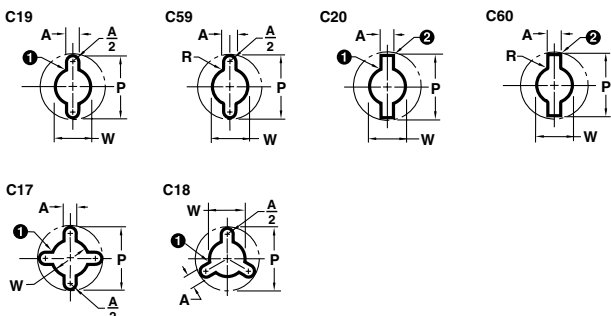

Reflected View — Punches and Guides

The Reflected View is used for Punches and Guides. It is the view as seen in a mirror held below a punch or guide in its operating position.

It is the same as a Plan View from the head end, in which the point shape is shown dotted except a Reflected View is shown with solid lines.

The Reflected View simplifies design... eliminates confusion. Shapes on the part print, strip layout, punch, die button and guide are the same basic view. Orientation for locking devices is the same position on all components.

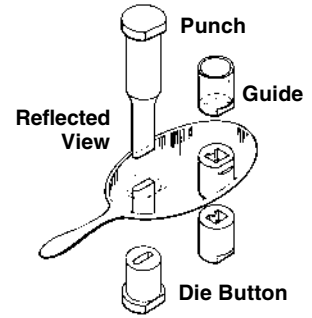

Note: Must identify as REFLECTED VIEW on punch drawing.

How to Order:

Punches

Specify: Quantity, Type (change Shape Code to C), Shape Number, Dimensions, Steel and Locking Device.

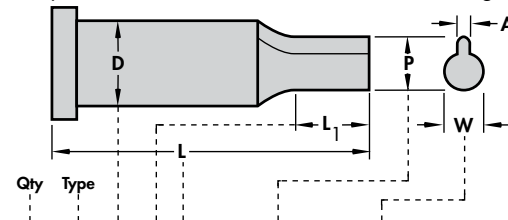

2 DPC13-1950 C 13 P 8.00, W 4.00, A 1.99, M2, X2

Die Buttons and Guides

To assure proper relationship with punches, it is necessary to specify punch dimensions and clearance per side (Δ) when ordering die buttons and guides.

Example:

Die Button: 2 DRC 13 - 25 C13 P8.00, W4.00, A2.00, M2, X2, Δ 0.05

Guide: 2 DFC 13 - 16 C13 P8.00, W4.00, A2.00, X2, Δ 0.013

Dayton will assure the proper clearance of die buttons and guides to the punch when ordered in this manner.

Mono-lobes

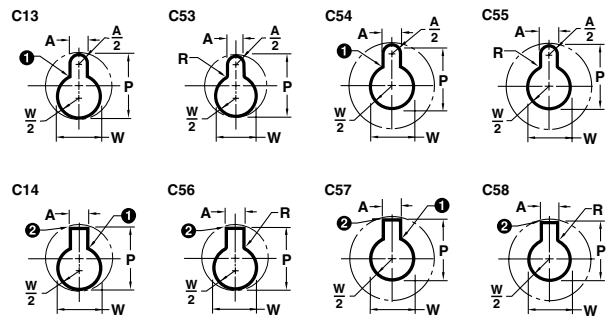

Keys

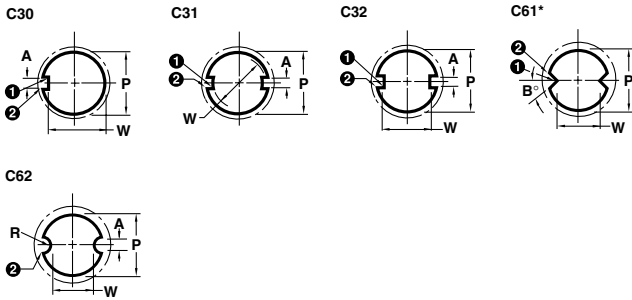

Triangles/Trapezoids

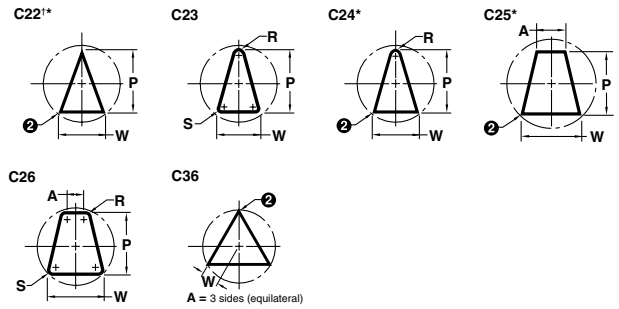

Miscellaneous

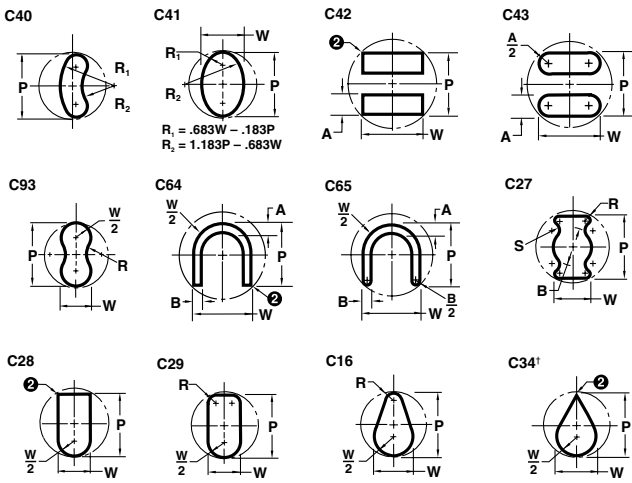

U's

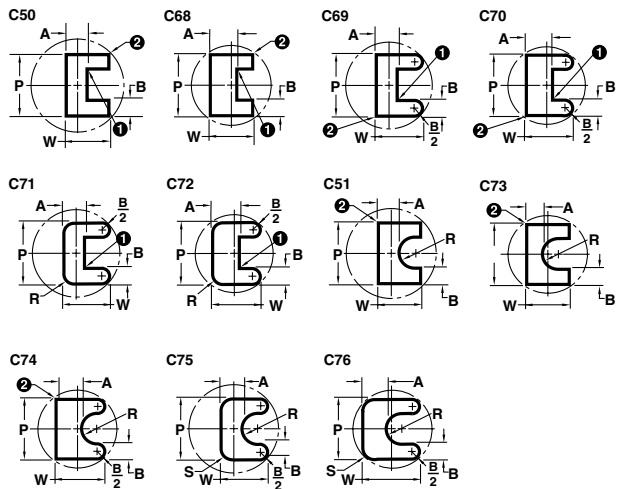

T's

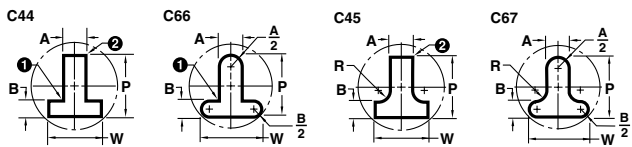

L's

When "WW" or "PP" is not specified shape will be furnished P&W central.

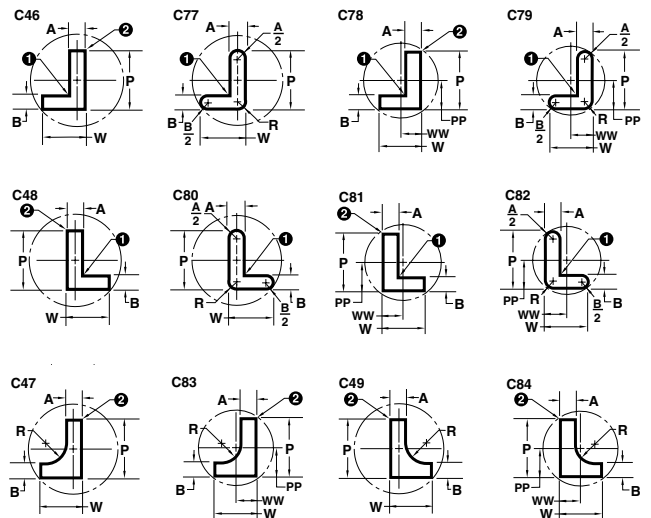

Polygons

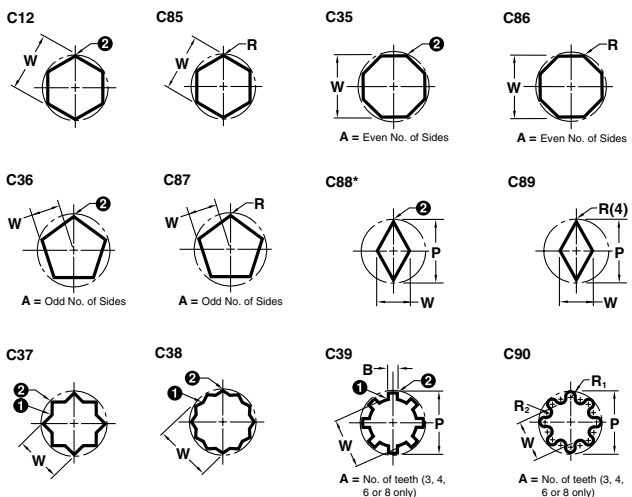

Duo Tees

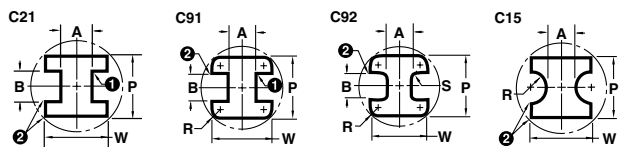

Locking Devices

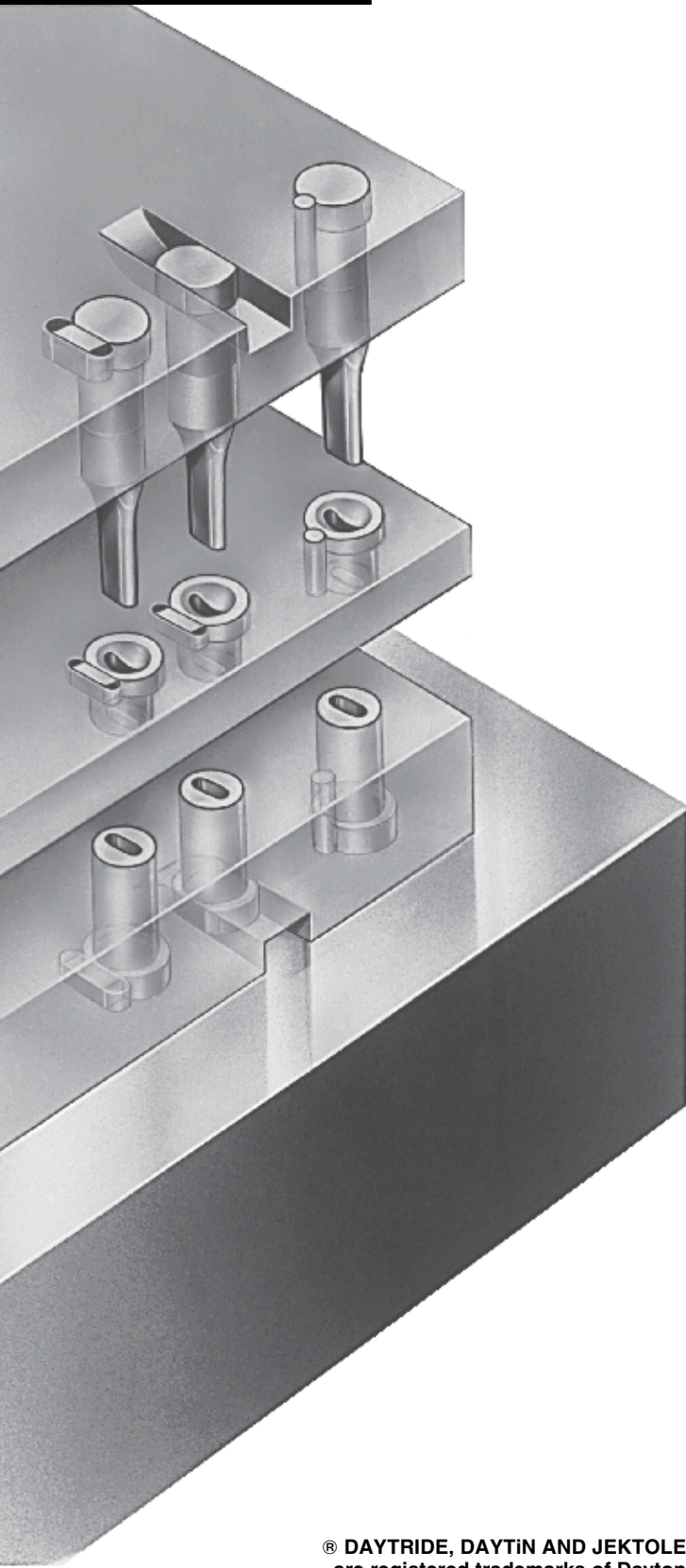

® DAYTRIDE, DAYTIN AND JEKTOLE are registered trademarks of Dayton Progress Corporation.
ALL TRILITERAL DESIGNATORS are trademarks of Dayton Progress Corporation.

Orientation

The standard location for all locking devices is 0° and is always on the long side (P) of the shape. Custom locations are measured counterclockwise from 0°.

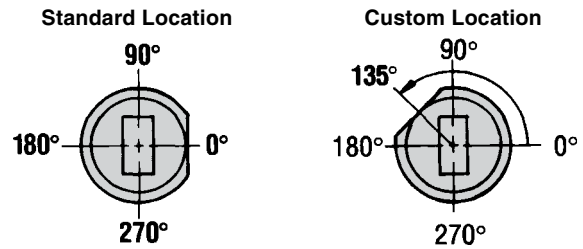

Views

A Plan View is used for the die button and a Reflected View is used for the punch or guide. The Reflected View, a mirror image (see Ordering Information Section on page 18), simplifies orientation... all locking devices are in the same position.

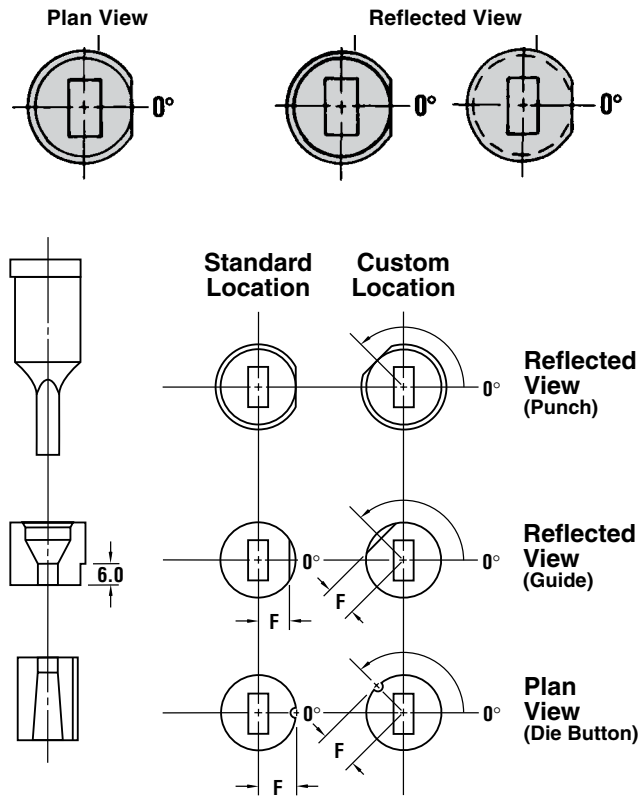

How to Specify

The most common locking devices, flat, double flat and dowel are available. Select the type then add the code to the component descriptions shown to the right.

How to Order

1 DJJ 13-2563 P 8.0, W 6.5, M2, X2
3 DR0 10-25 P 5.150, W 2.650 A2, X2

Location Tolerance

Flat		Dowel	
F	Radial	F	Radial
+0.005	0.01/20	+0.005	0°2'
-0.000		-0.000	

Flats

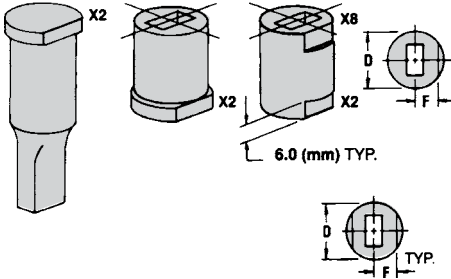

F Dimension (0.5D on Headed Products)

Headless Die Buttons and Guides

Body Ø ▶	05	06	08	10	13	16
F	2.2	2.6	3.5	4.3	5.6	6.9
Body Ø ▶	20	22	25	32	38	40
F	8.7	9.5	10.8	13.8	16.5	17.4
Body Ø ▶	45	50	56	63	71	
F	19.5	21.7	24.2	27.3	30.7	

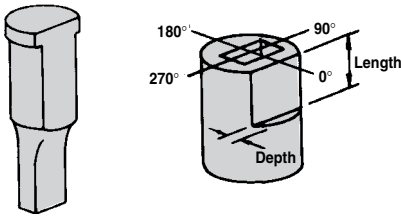

Note: depth of flat is taken from shank, not the head on punches.

Dowel Slots

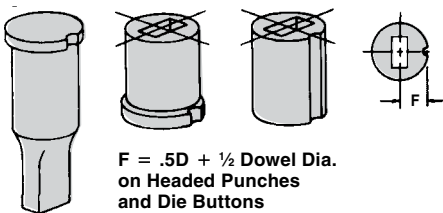

F = .5D + 1/2 Dowel Dia.
on Headed Punches
and Die Buttons

Standard/ Alternate Locations

Definitions:

Standard Location is at 0°.

Alternate Location is 90°, 180° or 270°. Alternate Locations are available at no additional charge.

Single Flats: X2 & X8

Locking Devices	Punches	Buttons
X2	Top	Bottom
X8	N/A	Top

Order Example:
X2 - 90°

Double Flats: X3

Locking Devices	Punches	Buttons
X3	Top	Bottom

Order Example:
X3 - 90°

Second Flat is *always parallel* to the first flat.

Additional Flats

Code	Depth	Length
X81	1.5	13
X82	1.5	16
X83	1.5	20
X84	1.5	Full Length
X85	2.5	13
X86	2.5	16
X87	2.5	20
X88	2.5	Full Length
X89	Specify Dimensions	

Dowel Slots: X0*, X4, X41 & X43

Locking Devices	Dowel Ø
X0*	3.0
X4	3.0
X41	4.0
X43	6.0

Order Example:
X0 - 180°

* Available on headless die buttons only

Custom Locations

Definition:

Custom Location is *any angle other than*: 0°, 90°, 180° or 270°.

Single Flats: X5 & X9

Locking Devices	Punches	Buttons
X5	Top	Bottom
X9	N/A	Top

Order Example:
X5 - 135°

Double Flats: X6

Locking Devices	Punches	Buttons
X6	Top	Bottom

Order Example:
X6 - 135°

Additional Flats

Code	Depth	Length
X91	1.5	13
X92	1.5	16
X93	1.5	20
X94	1.5	Full Length
X95	2.5	13
X96	2.5	16
X97	2.5	20
X98	2.5	Full Length
X99	Specify Dimensions	

Dowel Slots: X1*, X7, X71 & X73

Locking Devices	Dowel Ø
X1*	3.0
X7	3.0
X71	4.0
X73	6.0

Order Example:
X71 - 135°

F Dimension for Headless Die Buttons Only

Body Ø ▶	05	06	08	10	13	16-25	32-71
X0/X1	.5D	.5D	.5D	.5D	.5D	.5D	.5D
X4/X7	3.5	3.9	4.7	5.5	6.7	.5D	.5D
X41/X71	4.0	4.4	5.2	6.0	7.2	.5D	.5D
X43/X73	5.0	5.4	6.2	7.0	8.2	.5D+1.0	.5D

Key Flats vs. Dowel Slots

Maximum hole dimensions in die buttons were designed with key flats in mind. There are instances where, if using a dowel slot, the dowel hole could break into the relief. For this reason there are two ways to specify the location of the dowel. **X0** (standard/alternate location) and **X1** (custom location) are located .5D from centerline. However, when hole dimensions are approaching the high limit of "P" **X4** (standard/alternate location) or **X7** (custom location) may be

specified. This relocates the dowel outward to assure no interference between the dowel and relief. Note, when the die button diameter is 16-71, the centerline dimension is .5D on all dowels.

To determine if you will have an interference problem see Die Button Construction on page 14.



Form Punch Shapes

Dayton Progress Form Punches are available on round punches (i.e., those designated as standard "X" shaped punches).

When ordering, change the "X" designator to a "W." In addition, specify other dimensions, as shown in

the example below. Specify alterations, if applicable.

The shapes shown below are standard, but are not the only shapes Dayton provides. Others are available with a detailed drawing attached to the order.

Form Punches are also available on standard punch blanks. Form Punches other than those are available as specials.



HOW TO ORDER

Specify: Qty. Type Code L Steel W Shape P PP LA Alterations
Example: 2 DPW 13 1360 M2 W201 10.00 PP5.00 LA50.00 XNT

"P" is the point dimension of the product. The "P" dimensions are not shown below. When "P" = "D," shank tolerance applies.

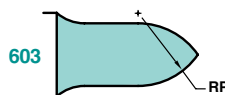
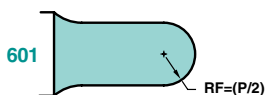
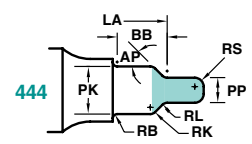
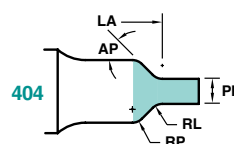
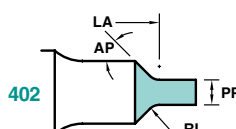
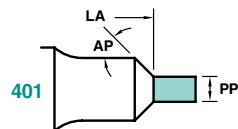
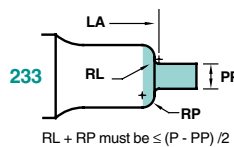
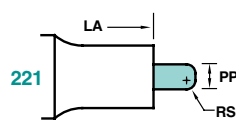
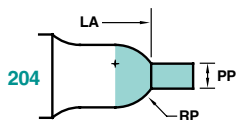
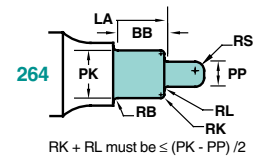
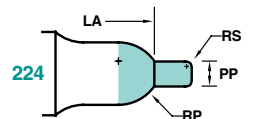
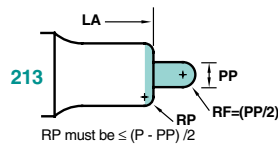
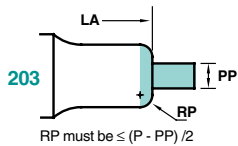
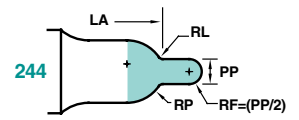
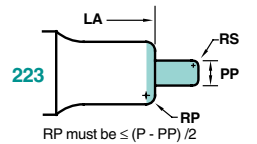
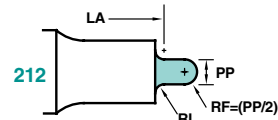
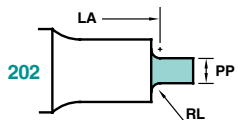
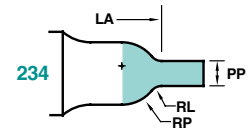
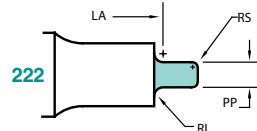
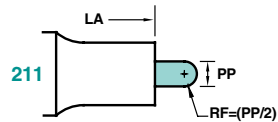
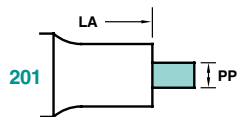
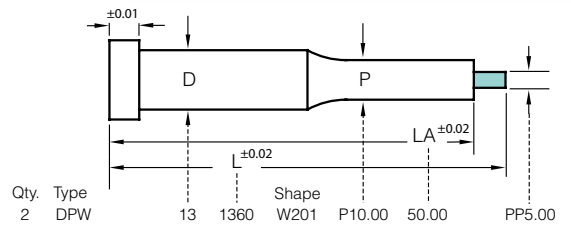

Form Punch Shapes

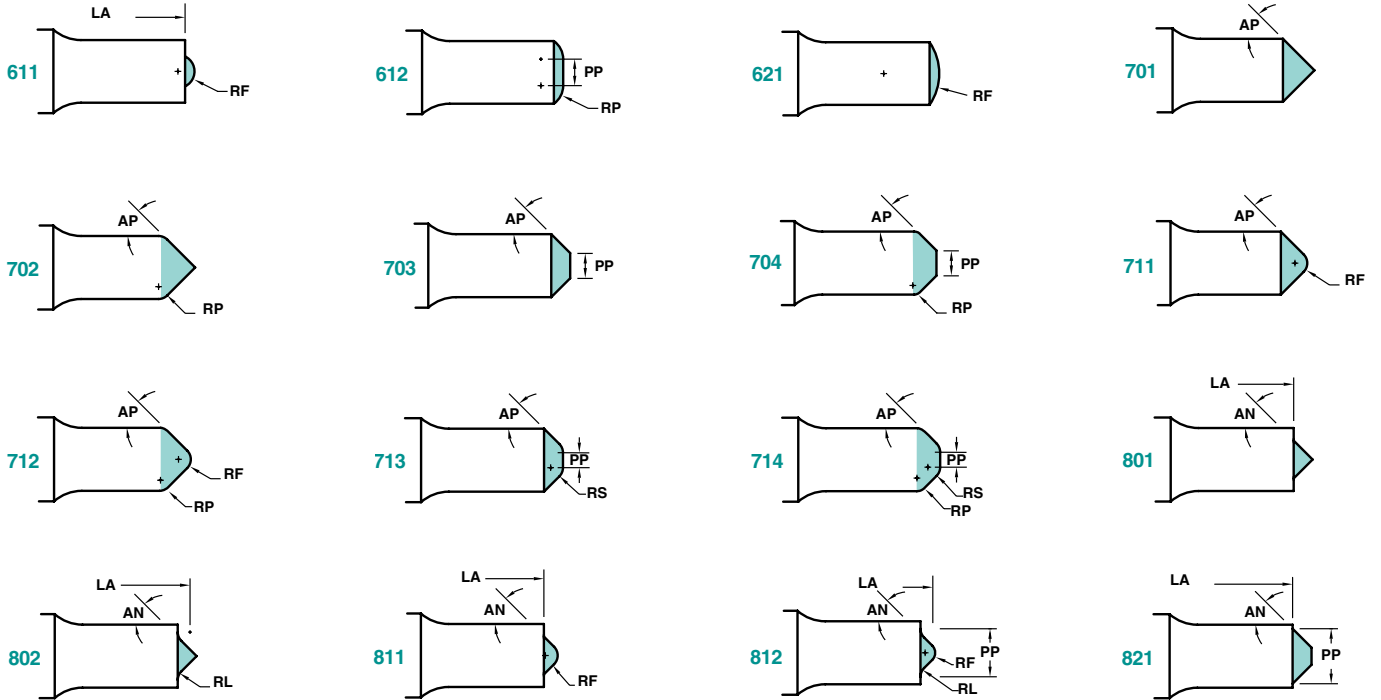

Form Die Button Shapes

Dayton Die Buttons are available for all the Form Punches shown here, i.e., round punches designated as standard "X" shaped punches. When ordering, please

change the "X" designator to a "W." Die Buttons are available as headed or headless with a counterbore relief, or as headed or headless with a tapered relief.



*B (Land Length) will be per catalog standard, unless XB is ordered. O.A.L. will be held to LL tolerance, i.e., $\pm .02$.

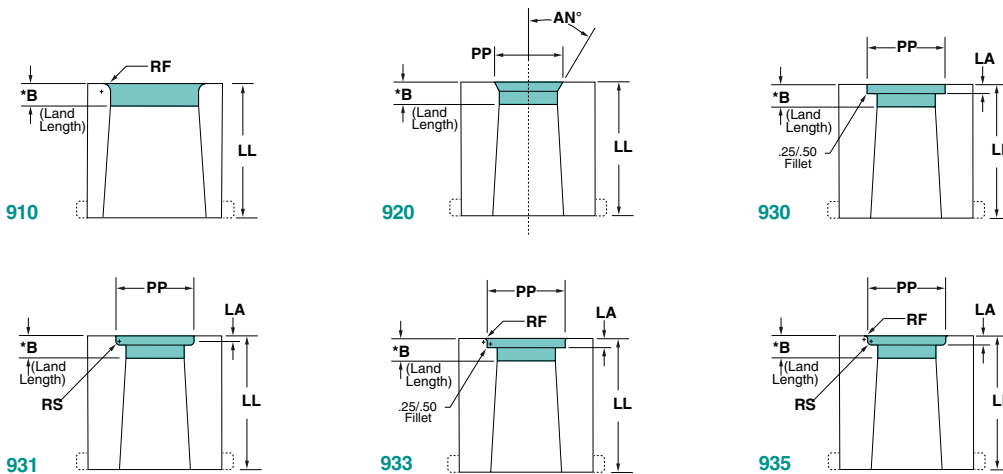

HOW TO ORDER

Specify:	Qty.	Type	Code	LL	Steel	W Shape	P	PP	LA	RS	RF	AN°	Alterations
Example:	4	DNW	25	30	M2	W935	13.00	14.00	2.00	1.25	1.00		XNT

Surface Treatments and Coatings

Some catalog products can be coated to increase hardness, reduce galling, and improve wear and/or corrosion resistance. These coatings and treatments are available for M2 and PS4 material.

Surface Treatments

DayKool™ (XCR)—A cryogenic steel conditioning process used in addition to heat treating. An effective way to achieve optimum toughness, improved strength, and dimensional stability. Used primarily with hard, thick materials.

DayTride® (XN)—A low temperature, cost-effective surface application that treats all exposed surfaces. Provides increased dimensional stability. Ideal for punches and die buttons. Approx. hardness: RC73.

XVP—A thin film coating provides superior hardness (harder than carbide). Super-smooth finish on the point helps reduce galling and maintenance. Ideal for higher-than-normal punching frequency.

XPS—Super-smooth polish on the point to reduce galling and improve punch life. Use with the appropriate coating for your application to maximize punch life and reduce maintenance costs. Excellent for extruding applications.

Abrasive Wear

DayTIN® (XNT)—Excellent wear resistance and lubricity. Not recommended for stainless steel, copper, or nickel. A good general-purpose coating. Approx. hardness: *Vickers 2300.

TiCN (XCN)—Ultra-hard (harder than carbide), thin coating. Provides superior abrasive wear resistance and lubricity. A very good general-purpose coating for all materials. Upgrade over XNT. Approx. hardness: *Vickers 3000.

DayTAN™ (XAN)—Ultra-hard (harder than carbide), high-aluminum coating. Provides high temperature resistance. Well-suited for applications where surface heat is generated. Ideal for HSLA, dual phase, and TRIP steels. Upgrade over XCN. Approx. hardness: *Vickers 3400.

ZertonPlus™ (XNA)—Superior hardness (harder than carbide); provides superior abrasive wear resistance and excellent lubricity. Provides highest temperature resistance, thermal shock stability, & hot hardness. Approx. hardness: *Vickers 3200.

Adhesive Wear

XNM—A solid lubricant coating. Provides both lubricity and wear resistance not available from other PVD or CVD processes. Ideal for aluminum, copper, pre-painted, and galvanized steels. Approx. hardness: *Vickers 2000.

XANL—High hardness and temperature resistance of XAN coating topped with an anti-frictional coating with excellent lubrication properties. Approx. Hardness: Vickers 3000.

XCD—Diamond-like carbon coating. Combines high hardness with an extremely low coefficient of friction. Good protection against abrasive and adhesive wear. Ideal for aluminum. Approx. hardness: *Vickers 5000.

XCDH—Super-smooth finish combined with advanced DLC coating for a very low coefficient of friction with extremely high wear resistance. Approx. hardness: *Vickers 5000.

XCDP—Super-smooth finish combined with a DLC coating for a very low coefficient of friction with high wear resistance. Excellent for stamping aluminum. Approx. Hardness: Vickers 2800.

Extrusion Coatings

XNP—The ultimate coating for improved resistance to galling; excellent wear resistance, superior surface finish, and high lubricity. Ideal for extruding and forming applications. Tolerance is ± 0.005 mm. Approx. hardness: *Vickers 3100.

XNAProgress (XNAP)—Ultra-hard coating that absorbs shear stress; provides excellent high-temperature resistance. Ideal for stamping where tools are exposed to extreme stress profiles. A good alternative to TD coating without the dimensional changes associated with that process. Approx hardness: *Vickers 3200.

Miscellaneous Coating

CRN—Excellent adhesion, high toughness, and good corrosion resistance. Primary applications are metal forming (copper, brass, & bronze), metal die casting, and plastic injection molding. Approx. hardness: *Vickers 1800-2100.

* Vickers used when RC exceeds 80.

Shear Angles

Shear Angles can be applied to all punch points. These angles are used primarily to reduce slug pulling. Single and Double Shears can be used to reduce the punching force as well as minimize slug pulling. These alterations are pre-priced and do not add to the standard delivery of the product.

Shear Angles are also available on Classified Shapes, but are available as special order only.

For your reference standard head flat and dowel locations are at 0° . For ball lock punches the standard ball seat location is at 90° .

Simply add the alteration code shown next to the drawings, and the angle desired, to your punch catalog number. Tolerance on all angles is ± 15 minutes.

How to Order:

Specify: Quantity
Product
Alteration

5 DJB 20 100 PS XS23 A3°

For Round Punches Only

XS19
Nail Point

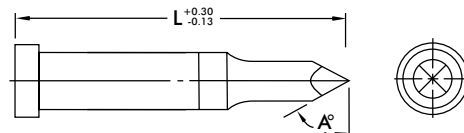

XS20
Chamfer

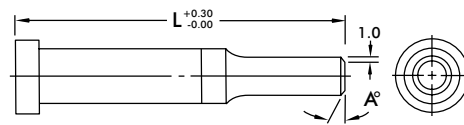

XS21
Conical

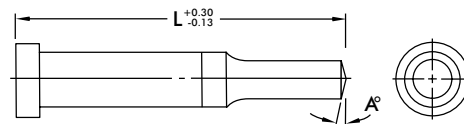

For Round & Shape Punches

Shown as reflected view.

XS22
Double Shear

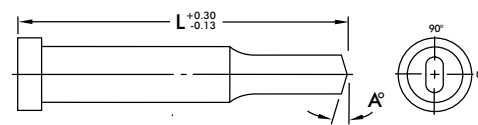

XS23
Single Shear

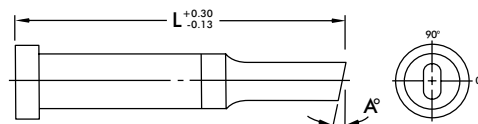

XS24
Single Shear
Angle with Flat

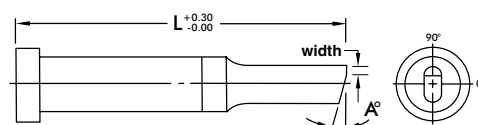

Commitment to Quality & Customer Satisfaction

Dayton Lamina is a leading manufacturer of tool, die and mold components for the metal-working and plastics industries. As a customer-focused, world-class supplier of choice, we provide the brands, product breadth, distribution network and technical support for all your metal forming needs.

Our goal is to give our customers the most innovative and value-added products and services.



DAYTON Lamina™

a MISUMI Group Company



Lamina® LEMPCO

*Dayton Lamina's line of Danly products is available only to North America.

www.daytonlamina.com